

VOYAGER PRO

QUICK-START

1. MOUNTING THE DOCK:

Voyager Pro's dock is made to be bolted to the vehicle. Use the mounting hardware included in your kit or any AMPs style mount from RAM Mounts rammount.com. Voyager Pro snaps in and out of the dock for quick removal when not in use.

- Voyager Pro can be locked to the dock using the included 1.5mm Allen wrench. *Turn either way to lock, set to center to unlock.*
- Add dielectric grease to the dock's pins to increase lifespan and add protection against water.

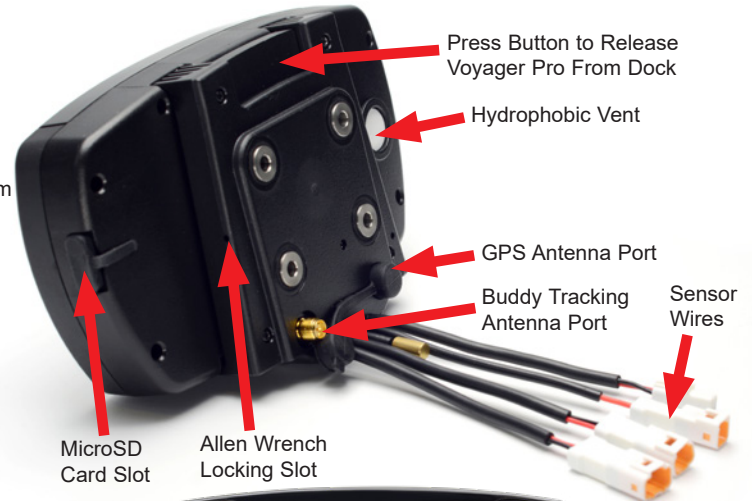

2. VEHICLE SENSORS:

The vehicle power connection must be installed. Install the ignition sensor to enable tach features. Install the engine temp sensor to enable engine temp features. *Voyager Pro comes set default to "GPS speed."* Optional wheel speed sensors can be found at trailtech.net.

3. DC POWER:

- **DC power required.** Do not connect Voyager Pro to AC power *except when using the AC wall charger.* Connect to a switched 12V DC power source to ensure power to Voyager Pro is cut when the vehicle is turned off (protects against a dead battery.)
- When wired behind the key switch and set to **CHARGE-ALWAYS**, charging will begin immediately. Or, use the tach ignition sensor with the **CHARGE-WHEN-RUNNING** vehicle profile setting.
- Voyager Pro will run approximately one hour on a full battery charge without external power. Remove it from the vehicle for route planning and file uploading at your computer.
- The below menu options need to be changed when Voyager Pro is used without a connection to vehicle power:
 1. *Vehicle Profile > Wake Detection, Speed Source, Charge Mode*
 2. *Maps and GPS Setup > AutoLog Source*
- NOTE: On some bikes, erratic tach readings can be fixed by wiring the power directly to the battery instead of behind the key switch.



4. USER MANUAL:

The user manual is embedded in Voyager Pro. Open the user manual by pressing the "?" icon. Look for "User's Guide" at the bottom of the main menu or go online to trailtech.net.

Press Here on Map Screen to Open the Slideout Menu

5. MAIN SCREENS:

Voyager Pro has several main screens. Press UP and DOWN on the buttons to move between screens. Press the menu button to open the main menu. On some screens, like the map screen, press the back button to open a sub-menu with screen-specific options.

6. ENABLE SCREENS:

Voyager Pro has a series of main information screens. Screens can be enabled/disabled in the settings menu. By default, the stop watch and satellite screens are hidden. Available screens include: the gauge cluster screen with a large speedometer, the tach screen with an animated tach graph, the map screen, the user definable screen, Bluetooth media screen, the stop watch screen, and the GPS satellites screen.



VOYAGER^{PRO} QUICK-START

7. MICROSD CARD SLOT:

A MicroSD card (not included in kits) enables transfer of tracks between Voyager Pro and a PC. During operation, make sure the card slot cover is properly seated to keep debris out. Tracks saved as GPX files on your computer can be placed on the MicroSD card, then imported onto Voyager Pro for viewing and route following. This is a great way to share recorded tracks, or for pre-planning trips. Music files saved on the MicroSD card can be played from the Media screen.

NOTE: Use exFAT type if you format your MicroSD card on a PC.



8. GPX FILES:

With the map screen's mini menu you can record, load, and save GPX files. GPX files are custom made tracks and riding areas that you can follow yourself, or create and share with the community using RideLeader.com.

9. BUDDY TRACKING:

Buddy Tracking connects multiple Voyager Pros to a private location tracking network. Once connected to the buddy tracking group you will see map markers (icons) showing the name and location of all group members. The technology supports up to 20 riders in a single group.

The mesh network capability increases the comfortable following distance between you and your buddies. The typical range between buddies is .5 to 1.5 miles, increasing with line of sight and fewer obstructions.

Tap the centering icon in the top left of the map screen to toggle "Buddy Mode" where the map will always keep buddies on-screen. Select a "Destination Buddy" to draw a line on the map between you and your buddy to easily keep track of them.

Note: The provided external V2V antenna is required to use buddy tracking features.



10. BUDDY BEACON:

When you activate the buddy beacon, your map marker flashes red on everyone else's screens. This is not a rescue beacon, it simply informs the riders in your group that you activated the beacon. *Note: You must be in range for buddies to see your beacon flashing.*

11. BLUETOOTH:

Connect up to two phones and two headsets. The headsets can function as an intercom between riders. Play songs from your phone through Voyager Pro to the headset. Receive phone text notifications and control incoming calls from Voyager Pro, so you can put your phone away and ride.

12. WARNING INDICATORS:

Set thresholds for max tach and/or temperature. Whenever Voyager Pro detects the vehicle is exceeding the limit, the indicator lights will alert you of the situation. Tach warnings flash, temperature warnings are solid. Set it up under vehicle profile in the main menu.





POWER AND TACH SENSORS INSTALLS

POWER CONNECTION:

FOR USE ON 12V REGULATED DC SYSTEMS ONLY!

Connecting to AC power will damage Voyager Pro and void the warranty.

Use a volt meter to confirm nominal 12V DC.

When charging, Voyager Pro MUST BE powered on (avoids draining vehicle battery).

Fuse: Introducing a fuse into the circuit before electronics is always a good idea.

Use a 2 amp fuse with Voyager Pro (not provided).

Vehicles with Regulated DC Power: Voyager Pro requires DC power. Vehicles with a battery or capacitor and regulator/rectifier produce DC power. Connect the power wire directly to the vehicle's 12V battery. Connect the red wire to the positive(+) battery terminal and the black wire to the negative(-) battery terminal.

Vehicles with AC Power: Use the Voyager Pro AC wall charger, or upgrade to a DC electrical system. Most carbureted MX bikes put out AC power, but Voyager Pro requires DC power.

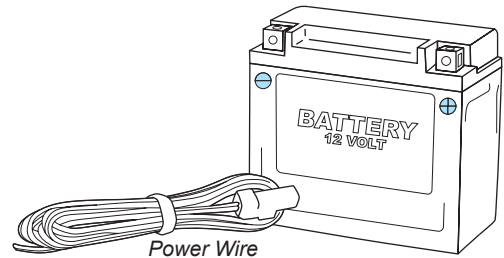

SENSORS:

The Voyager Pro vehicle sensors fasten securely to the dock using waterproof JST connectors.

The connectors are all different shapes, ensuring you do not plug a sensor into the wrong connector.



TACH IGNITION SENSOR:

The ignition sensor enables tachometer readings and the animated bar graph on the tach screen of Voyager Pro.

OPTION 1: (Preferred option for most vehicles.)

Capacitive coupling to spark plug wire:

1. To install ignition sensor wire, wrap the red part of the sensor wire around the coil wire 5 times.

If required, you may shorten the length of the ignition sensor. Be very careful when stripping back the black casing to avoid damaging the inner red wire.

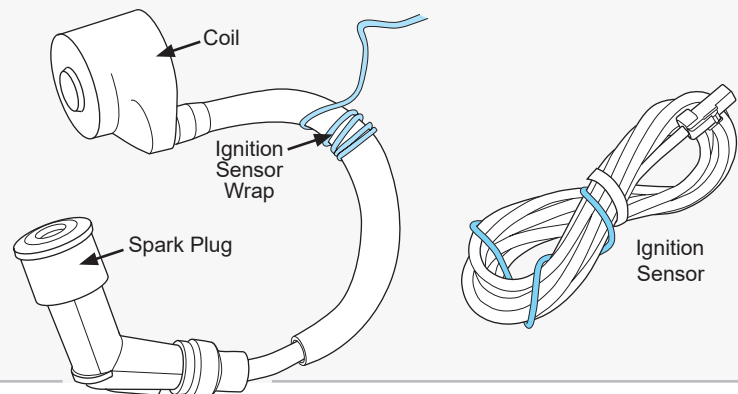

OPTION 2:

If the coil is attached to the spark plug, then wrap the sensor like this:

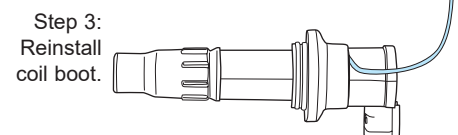
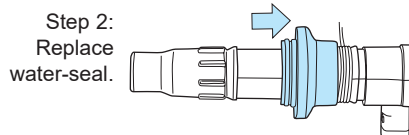
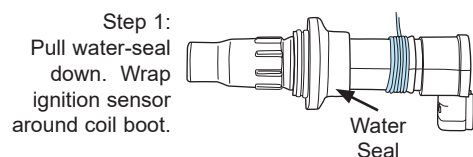



TEMPERATURE SENSORS AND ANTENNAS INSTALLS

TEMPERATURE SENSORS:

Most Voyager Pro kits contain a model-specific temperature sensor. Installing the temperature sensor enables temperature readouts on Voyager Pro's gauge screens. Alternative sensors are available.

Vehicles cooled with water use sensors to measure the fluid temperature, while air-cooled machines take the cylinder head's temperature at the spark plug. The radiator fin sensor is the easiest installation for water cooled applications.

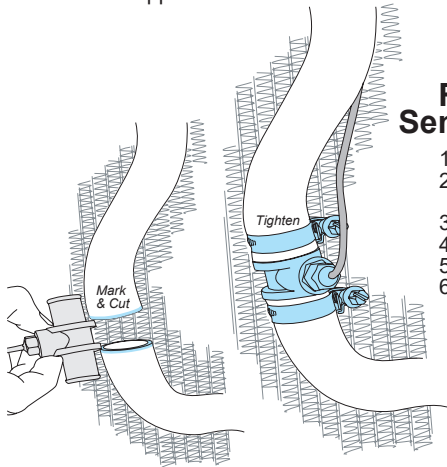

Radiator Hose Sensor Installation:

1. Drain fluid.
2. Measure inner diameter of hose *before* cutting.
3. Mark hose.
4. Cut hose.
5. Slide on hose clamps.
6. Install sensor & tighten hose clamps.

Radiator Fin Sensor Installation:

1. Confirm correct size.
2. Apply thermal grease to maximize heat transfer.
3. Carefully press sensor between radiator fins.

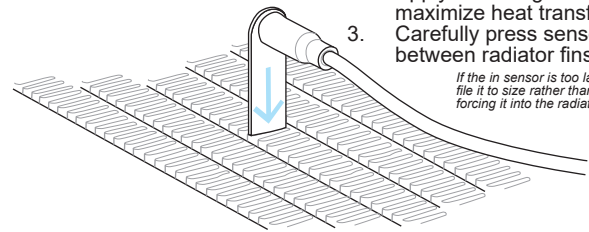

If the in sensor is too large, file it to size rather than forcing it into the radiator.

CHT Cylinder Head Spark Plug Sensor Installation:

1. Remove crush washer from spark plug.
2. Replace with temperature sensor.
3. Re-install spark plug.

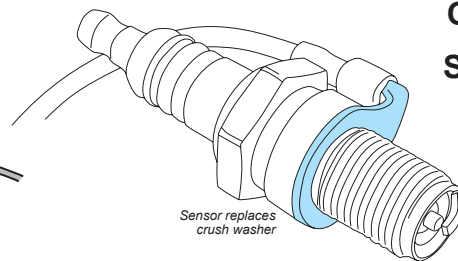

CVT Sensor Install: (Continuously Variable Transmission)

200°F+ Warning: CVT Belt wear occurs more rapidly at high temperatures.

Let the belt cool down to increase lifespan.

1. Drill 13/64" (5mm) hole in hard plastic CVT exhaust.
2. Thread sensor into hole.
The sensor threads are M6x10.
3. Use high temp RTV (silicone gasket sealer) to seal case cover.
Not included in kit.

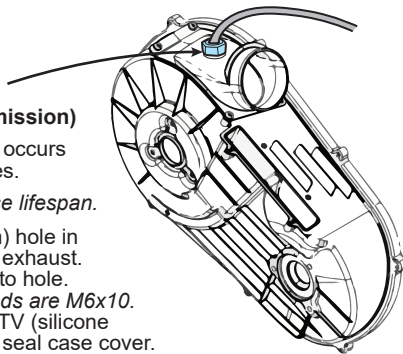

Screw Sensor Installation:

1. Remove radiator pressure relief bolt.
2. Replace with temperature sensor.

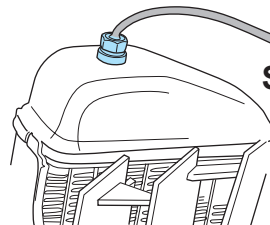

V2V ANTENNA:

Buddy Tracking Antenna:

The vehicle-to-vehicle antenna sends radio signals between your vehicle and other vehicles with Voyager Pro.

The V2V antenna is designed to be mounted to a non-metallic surface like a number plate or shroud, with the ears aimed vertically, up and down. Higher up on the vehicle is better, as the engine and metal panels can block reception.



V2V Antenna
*Required for
Buddy Tracking*

MOUNTING OPTIONS INSTALLS

UTV SURFACE MOUNT:

For UTV's and vehicles with a dashboard, this flat surface RAM mount is good solution. We recommend two composite RAM ball bases and a short arm as shown. We suggest locating Voyager Pro in the middle of the vehicle where both the driver and passenger have visibility.

Note: If bolting to a plastic surface, use a backing plate on the backside for a much more stable installation.

*Flat Surface
Mount
026-FS*

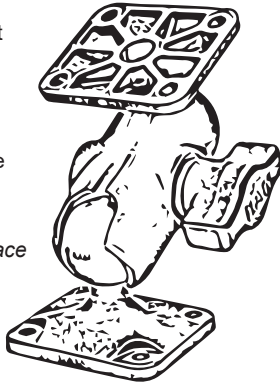

UTV ROPS MOUNT:

RAM mount for mounting Voyager Pro to a steering column or UTV roll cage. Safely conceals the strap clamp in a compact housing, so you won't have to worry about exposed sharp edges or unwanted loosening.

The preferred location to install this mount is on the roll cage bar. Even though it also works with most steering columns, it may block the built-in speedometer in the dash. Consists of RAM rail base, short arm and a composite base with the AMPs hole pattern. Comes with four M4x14mm screws to attach the Voyager Pro dock.

Included in the Voyager Pro UTV kit (922-125.)

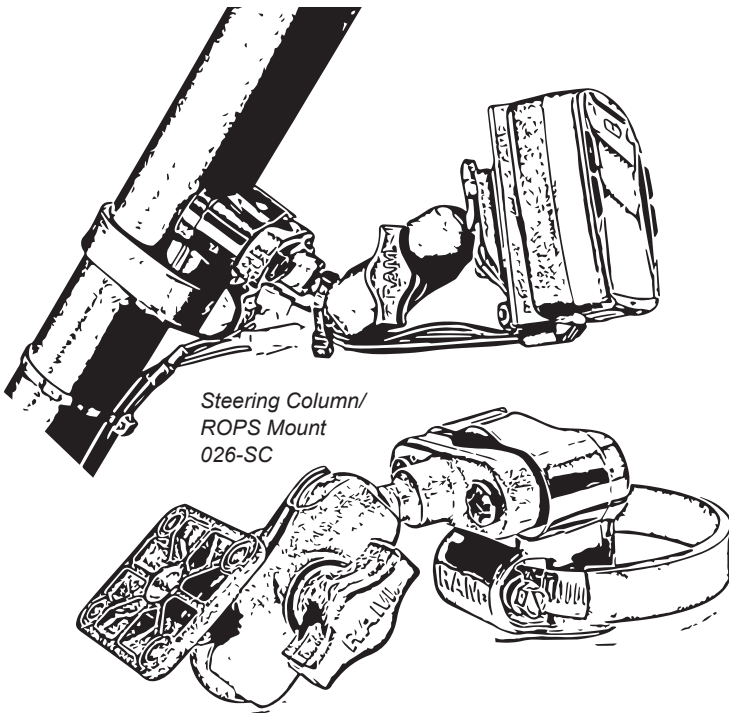

*Steering Column/
ROPS Mount
026-SC*

HANDLEBAR MOUNTS:

Voyager Pro plastic handlebar mounting hardware kit for 7/8" and 1-1/8" bars. Patented mount design has two points of articulation,

enabling a wide variety of mounting positions. Made from special high strength materials to withstand the rigors of powersports. Comes with four M4x14mm screws to attach the Voyager Pro dock. **Included in Voyager Pro kits.**

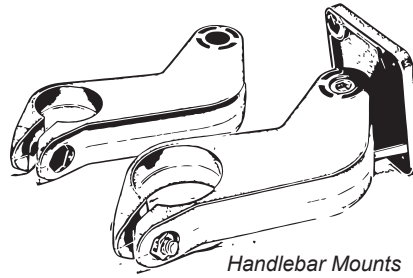

*Handlebar Mounts
9200-1000*

HANDLEBAR CENTER MOUNT:

Voyager Pro Center Mount for 1-1/8" bars, a strong upgrade for your Voyager Pro mounting. Aluminum CNC with matte black anodized finish.

Works with split bar clamps, like on KTM and Husqvarna. Comes with four M4x14mm screws to attach the Voyager Pro dock. Find on trailtech.net.

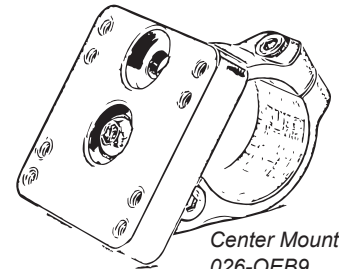

*Center Mount
026-OEB9*

SUCTION CUP MOUNT:

RAM mount for windshields or smooth surfaces. Consists of a 3.3" diameter RAM suction cup twist lock base connected to a diamond base with ball, short arm and a composite base with the AMPs hole pattern for attaching the Voyager Pro dock. **Included in the Voyager Pro automotive kit (922-124.)**

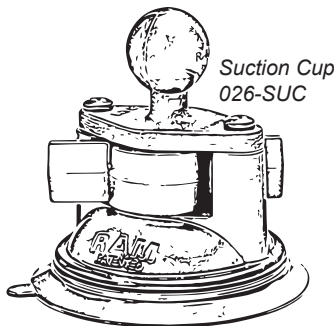

*Suction Cup
026-SUC*