

Preparation

If the handlebar grips are not open at the end they will need to be cut open for the handguard to be fitted. Use a sharp knife to cut a hole in the end of each handgrip. On the right side the hole size should be neat and no smaller than the inside diameter of the throttle tube. Loosen the throttle assembly to move it outward about 20mm. Roll back the end of the grip and use a hacksaw to carefully cut off the end cap of the plastic throttle tube. Do not remove more than 3mm and take care not to cut the underlying handlebar. Before refitting, remove any burrs that could restrict throttle movement.

NOTE: Fits most bikes with front or side top triple clamp pinch bolts regardless of handlebar size or type.

Fitting Instructions

Installation is shown for the left side, repeat for right side with applicable parts.

Important: Use a mild thread locking compound on all bolts.

Remove the original, top triple clamp pinch bolts. Fit the clamp post (2), with the long flange bolts (6), to the top triple clamp. **Do not tighten at this stage.**

Attach the connecting arm (3) to the clamp post (2) with the bolts supplied (see diagram.) Diagram shows left side connecting arm with undercut towards the front.

Attach aluminium bar (1) to connecting arm (3) and handlebar end with applicable parts. Position aluminium bar (1) so it is horizontal when viewed from the side and tighten bolt (7).

Position all parts so they align with each other, and then tighten all bolts.

The flange bolt (5) that holds the connecting arm to the upright post should be tightened last.





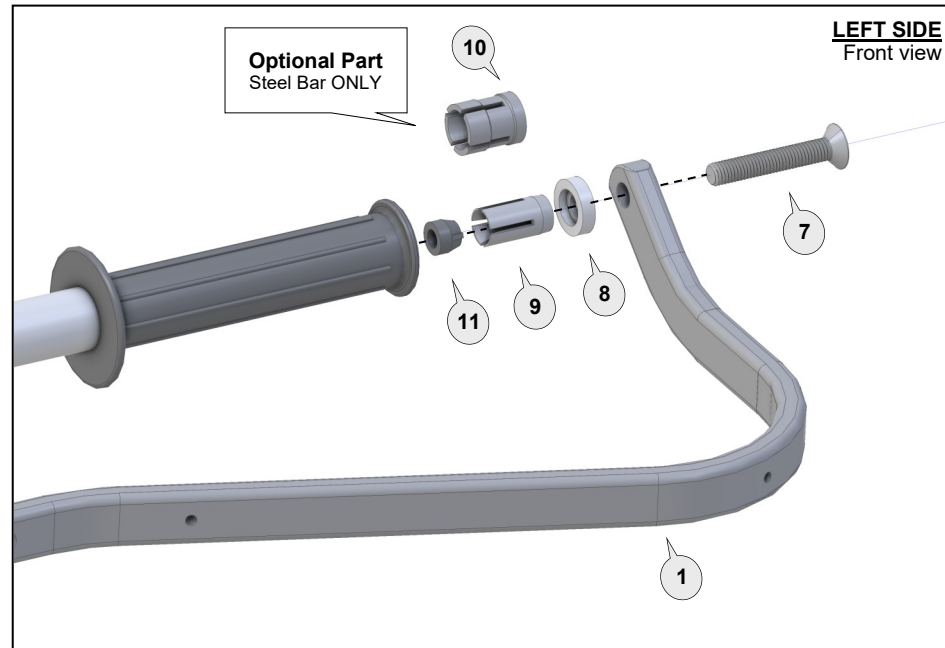
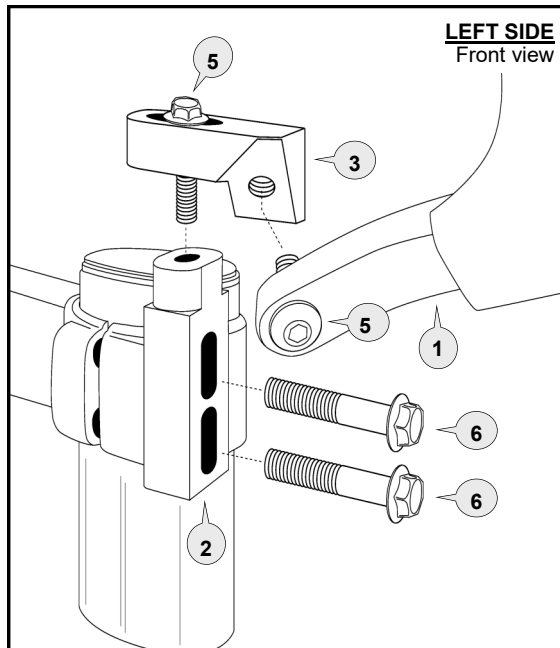

The upright post (2) can be adjusted up and down for height variation.

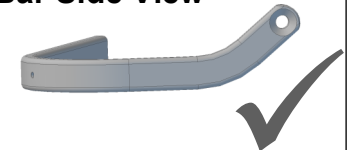

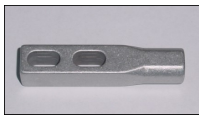
Note: If this triple clamp mounting is fitted to a Honda XR 250/400/600 you will need to purchase 4 x 65mm long bolts to use in place of the 4 x 60mm bolts supplied. This is to ensure you have a minimum of 12mm thread engagement.



Bar Side View

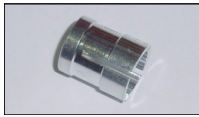

<p>1 Aluminium Bar</p>  <p>PN: BAR-V-030 Pcs. Left/Right Pair</p>	<p>2 Clamp Post</p>  <p>PN: TCP Pcs. 2</p>	<p>3 Connecting Arm - Left</p>  <p>PN: TCCA-L Pcs. 1</p>	<p>4 Connecting Arm - Right</p>  <p>PN: TCCA-R Pcs. 1</p>	<p>5 Flange Bolt 25mm</p>  <p>PN: M8X25FB10ZP Pcs. 4</p>	<p>6 Flange Bolt 60mm</p>  <p>M8X60FHB10ZP Pcs. 4</p>	<p>7 Flat Head Bolt 45mm</p>  <p>PN: M8X45FHCSZP Pcs. 2</p>	<p>8 Collar</p>  <p>PN: BBEC5M Pcs. 2</p>
---	--	--	--	--	---	---	---

<p>9 Expander</p>  <p>PN: BBE14A Pcs. 2</p>	<p>10 Collet</p>  <p>PN: COLLET14-18 Pcs. 2</p>	<p>11 Taper Nut</p>  <p>PN: NUT12 Pcs. 2</p>
---	---	--

Personalise Your Protection
Guard options sold separately

JET JET-003

VPS VPS-003

Storm STM-003

CARBON BCF-003

Recommended Torque Settings	
M6	10 Nm (7.4 lbf ft)
M8	20 Nm (14.8 lbf ft)

CAUTION:

Installation of the handguard is safety-relevant work and can be complicated. We recommend the installation be performed by a motorcycle service technician. Rideworx accepts no liability for damages caused by improper mounting. All screws, bolts and nuts, including all replacement hardware provided by Rideworx, should be tightened to the torque specified in the table. After the first 50km of riding check all screws, bolts and nuts are tightened to the correct torque. We recommend a medium strength liquid thread lock product on all fasteners.

WARNING:

Check operation of all handlebar controls, specifically the throttle, front brake, kill switch and clutch to ensure they are operating correctly and are in accordance with the OEM specifications. Do not ride the motorcycle if any controls are not operating correctly. Check periodically that all bolts are tight.

Disclaimer:

A failure to follow these fitting instructions could cause serious injury, death or property damage. These handguards are intended solely for use with motorcycles/ATV/snowmobiles/scooters that have not been modified. They are not designed to prevent injury or death while riding or in an accident or crash. The user must ensure that all controls are free of the handguards every time that they ride. By installing and/or using this product you acknowledge that you accept these terms and have followed the fitting instructions.



Phone: +61 (0)2 4271 8244
Email: info@barkbusters.net
Web: www.barkbusters.net

