

# INSTALLATION



Thanks for purchasing our T&T meter. Before operating this unit, please read carefully the instruction sheet and retain it for future reference.

## Notice

1. This meter work on DC 12 volts applications only.
2. For proper installation, please follow the steps described in the instruction sheets. Any damages caused by wrong installation shall be imputed to the users.
3. Don't break or modify the wire terminals. To avoid any short circuit, do not pull the wires out of the terminal when installing.
4. Do not disassemble or change any parts.
5. Opening the instrument will void any warranty. Maintenance or repair should be executed by our professionals only.

### MARK MEANING:

⚠ Some procedures must be followed to avoid damages to the instrument.

**⚠ WARNING!** Some procedures must be followed to avoid injuries to the user or others.

**⚠ CAUTION!** Some procedures must be followed to avoid damages to the vehicle.

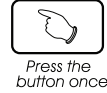

## 1-1 Accessories

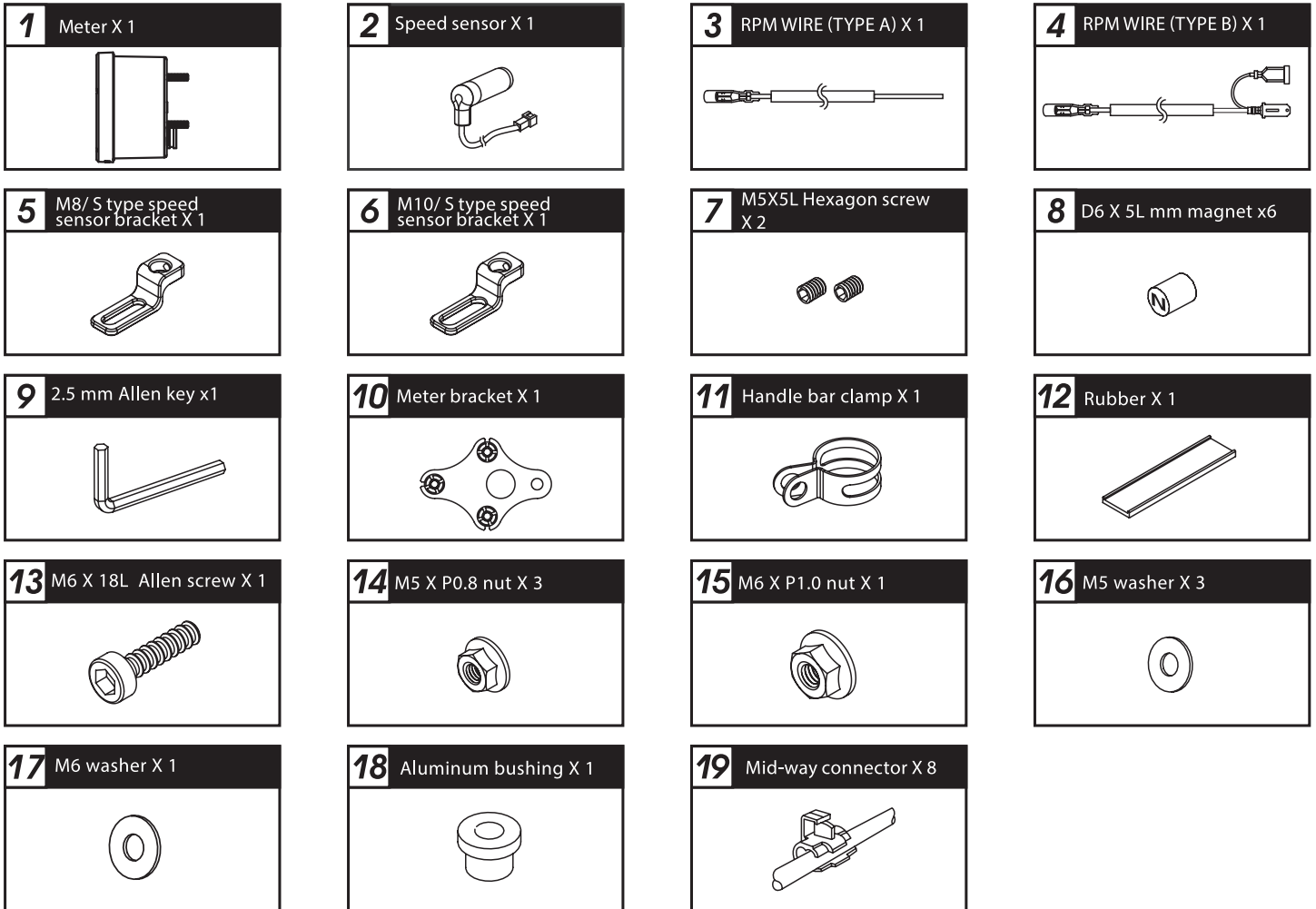

**NOTE** Please contact your local distributor if the items received in the box are not the same as the one listed above.

## 1-2 Optional accessories

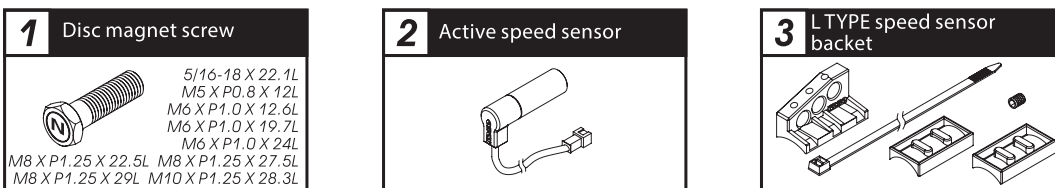

**NOTE** The optional active speed sensor can read up to 20 pulses and do not require the installation of any magnets to pick up the speed signal. Note that the passive speed sensor supplied with the instrument can read up to 6 pulses.

**NOTE** Some of the optional accessories might not be available in your country. Contact your local distributor to get more details.

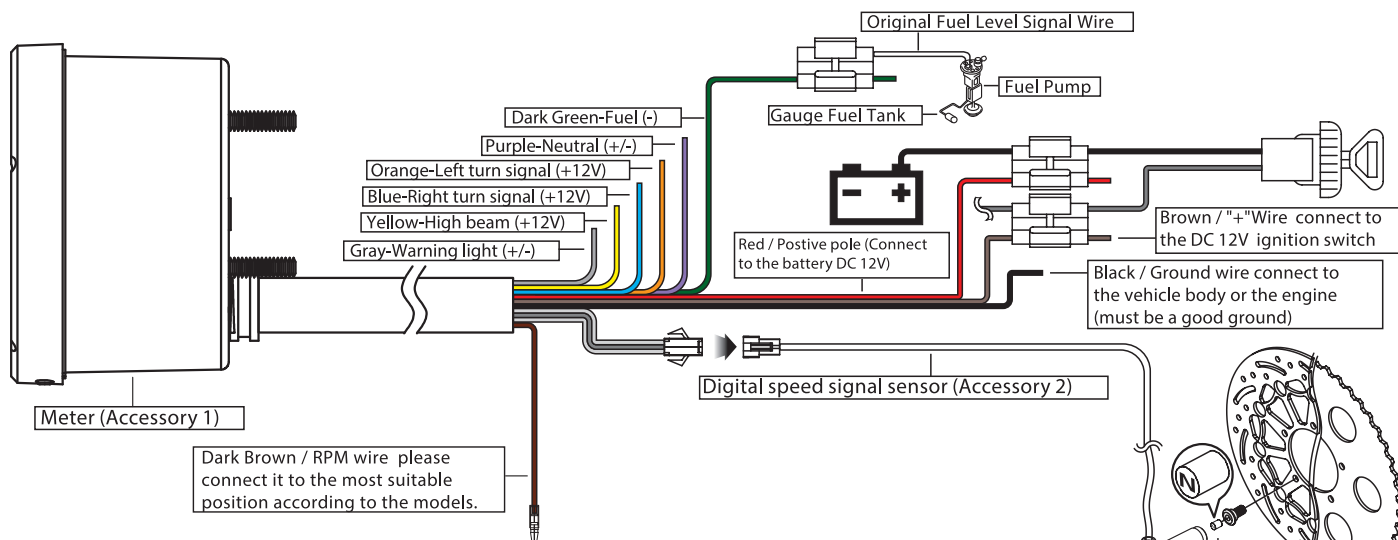

Dark Brown / RPM wire please connect it to the most suitable position according to the models.

Main power switch wire reference:

	Power	Key on	Ground
YAMAHA	Red	Brown	Black
HONDA	Red	Red / Black	Green
SUZUKI		Black	Gray / G reen
KAWASAKI	White	Brown	Black / Yellow
KYMCO	Red	Black	Green
SYM	Red	Black	Green
PGO	Red / White	Orange	Black

**NOTE** The color listed above may differ depending on the model and year.

RPM wire reference:

	YAMAHA	HONDA	SUZUKI	KAWASAKI	APRILIA	BMW	BENELLI	BUELL	CAGIVA	DUCATI	H-D	MV	TRIUMPH
Power	Yellow / Black	Yellow / G reen	Yellow / Blue	Light Blue	Gray / Violet	Black	Gray / Violet						
Ground	Pink	Gray / G reen	Gray / G reen	Pink	Gray / Yellow	Red							

**NOTE** The color listed above may differ depending on the model and year.

Fuel indicator wire reference:

	YAMAHA	HONDA	SUZUKI	KAWASAKI
Power	Green	Yellow / White	Yellow / White	Yellow / White
Ground	Yellow / White	SYM	Gray	
		PGO		

⚠ The fuel sensor is electronic type, do not connect in parallel with the original wire - otherwise the fuel gauge won't display. The wrong installation of the fuel wire might damage the instrument.

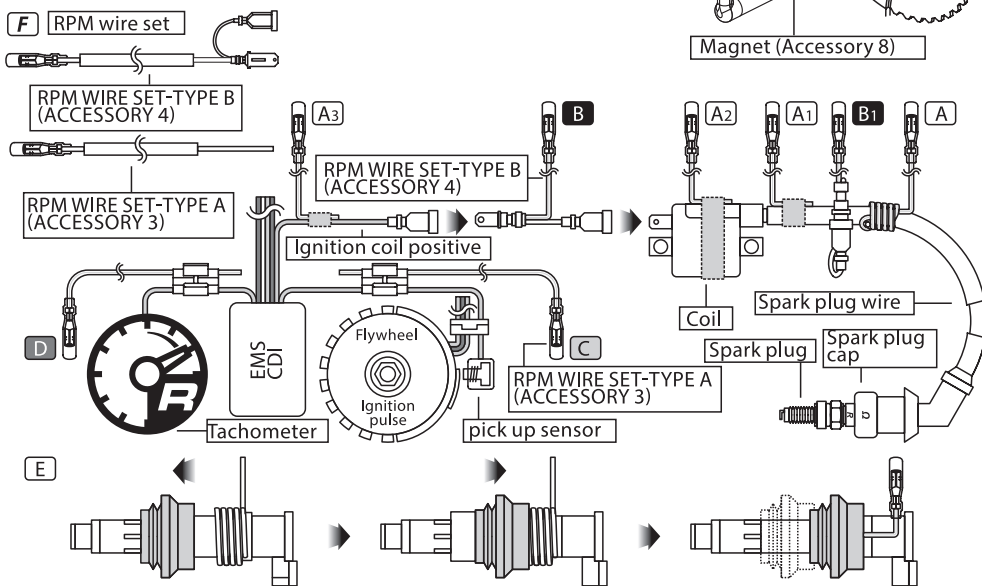

**NOTE** When connecting the power wire, please follow carefully the instruction. If the red & brown wires are connected in parallel, the meter won't work properly.

⚠ The RPM wire installation

- A. Wrap the RPM wire at least 5 times around the spark plug wire.
  - A1. Use adhesive tape to attach the RPM wire (Type A) onto the spark plug wire.
  - A2. Use adhesive tape to attach the RPM wire (Type A) on the spark plug cap.
  - A3. Use adhesive tape to attach the RPM wire (Type A) on the coil positive pole wire. For some models with the coil negative wire, please tape the RPM wire (Type A) on the negative wire to get the RPM signal. (For example, the YAMAHA V-max 1200)
- B. Connect the RPM wire (type B) to the ignition coil positive pole.
- B1. Wrap the RPM wire (type B) on the spark plug wire by connecting the male and female connectors.
- C. Connect the RPM wire (Type A) to the pick up sensor.
- D. Connect in parallel the RPM wire (Type A) with the original tachometer signal wire (This method is available only when the original speedometer comes with a tachometer on it. You could get the proper RPM wire information from the service manual of your bikes.)
- E. For the applications with the new model of ignition coil, please wrap the RPM wire (Type A) at least 5 times around the spark plug as shown on the above drawing.
- F. Use the method mentioned above to install the RPM wire, and then connect the ground wire to the bike body or the engine (must be a good ground).  
For multi-ignition models, we will suggest you to get the signal on the first ignition. The best signal source will be in order as D>C>B>A, we will suggest you to check different ways if you have problems to get the RPM signal.

## 2-2 Installation instruction

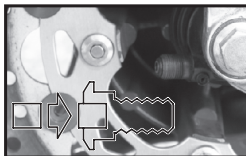

Put the magnet into the brake disc screw hole.

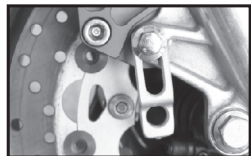

Install the s type sensor bracket.

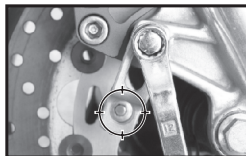

Adjust the sensor bracket position to make sure the sensor is facing the magnet to prevent bad speed signal.

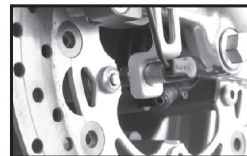

Install the speed sensor on the bracket.

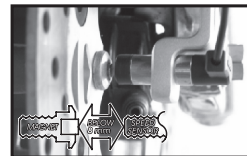

In order to get a good speed signal, the distance between the speed sensor and magnet should be under 3 mm.

P.S.



Higher number of magnets installed on the disk brake will result in a faster speed display on the gauge. The letter "N" on the magnets must face the speed sensor in order to pick up correctly the speed.

EX 1: If the disk brake has 3 screws, you can install 1 or 3 magnets.

EX 2: If the disk brake has 4 screws, you can install 1, 2 or 4 magnets.

EX 3: If the disk brake has 5 screws, you can install 1 or 5 magnets.

EX 4: If the disk brake has 6 screws, you can install 1, 2, 3 or 6 magnets.

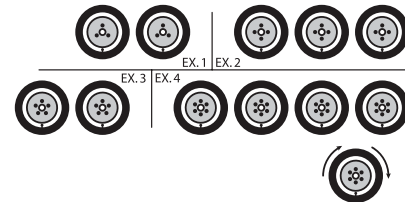

## 3-1 Basic function instruction

### Tachometer

- Display range: 0~10,000 RPM

### Telltale

- Turn signal (Green)
- Warning (Red)
- Neutral (Green)
- High beam (Blue)

### Fuel Level

- Display range: 6 levels.
- The fuel level begins to flash when only 1 level is left.

### MAX record

The meter will record automatically the top speed and RPM.

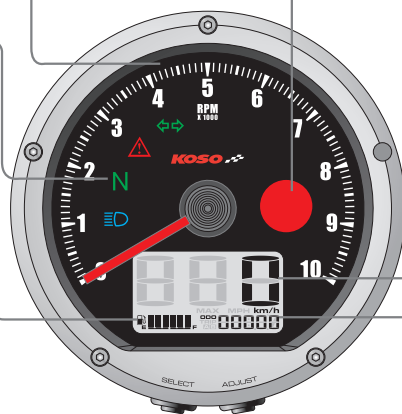

### Shift light

- Setting range: 0~10,000 RPM
- Setting unit: 100 RPM
- Warning: Light on (F-OFF), Flash (F-ON)

### Speedometer

- Display range: 0~360 km/h (0~225 MPH)
- Display unit: km/h or MPH (settable)

### Odometer

- Display range: 0~99999 km (mile), reset automatically after 99999 km.
- Display unit: 1 km (mile).

### Trip meter A.B

- Display range: 0~999.9 km (mile), reset automatically after 999.9 km.
- Display unit: 0.1 km (mile).

### Clock

- 24H

### Volt meter

- Display range: DC 8~DC 18 V
- Flashing warning when voltage is lower than 11.5 V or higher than 15.5 v.

## 3-2 Functions

●Speedometer	Display range: 0~360 km/h (0~225 MPH) Display unit: km/h or MPH	○The RPM input pulse	Setting range: HI (Positive wave pulse) Lo (Negative wave pulse)
○Display internal	< 0.5 second	●Fuel meter	Display range: 6 levels Display unit: Each level represent 16.6 % Setting range: 100Ω, 250Ω, 510Ω, 1200Ω, SW
○Odometer	Display range: 0~99999 km (mile), reset automatically after 99999 km (mile).	●Clock	24 H
○Trip meter A/B	Display range: 0~999.9 km (mile), reset automatically after 999.9 km (mile). Display unit: 0.1 km (mile).	●Volt meter	Display range: DC 8~18 V. Flashing warning when voltage is lower than 11.5 V or higher than 15.5 v.
○Tire circumference	Setting range: 300~2,500 mm Setting unit: 1 mm, Sensitive point: 1~20	●Backlight brightness Right	Setting range: 1-5 (Darkest)~5-5 (Brightest) Setting unit: Each level represents 20 %
●Tachometer	Display range: 0~10,000 RPM	●Effective voltage	DC 12 V
○The shift light	Setting range: 0~10,000 RPM Setting unit: 100 RPM	●Effective temperature range	-10~+60°C
○Warning	Light on (F-OFF) Flash (F-ON)	●Meter standard	JIS D 0203 S2
○The RPM input signal number setting	Setting range 0.5, 1~24	●Meter size	86,5 X 75 X 44.1 mm
		●Meter weight	+ or - 127.3 g
		●Indicator light color	Turn signal-green, Warning-Red, Neutral-green, High beam-blue

**NOTE** Design and specifications are subject to change without notice!

## 3-3 Button function instruction

Press the Select button

- 1.In main screen, press the Select button to enter the MAX record display.
- 2.In setting screen, press the Select button to choose the function you want to set.

Hold the Select button for 3 seconds

- 1.In setting screen, hole pressing the Select button for 3 seconds to go back to the main screen

Press the Adjust button

- 1.In main screen, press the Adjust button to choose the odometer, trip A, trip B, clock, volt.
- 2.In the setting screen, press the Adjust button to change the setting numbers.  
If you keep pressing down the Adjust button the number will increase quickly.

Hold the Adjust button for 3 seconds

- 1.In the main screen, hole the Adjust button for 3 seconds to reset the trip A, trip B and the MAX record.
- 2.In the ODO screen, hole the Adjust button for 3 seconds to switch between the km/h and mile/h.

Hold the Adjust button

- 1.In the setting screen, hold the Adjust button to add quickly the set value.

Hold the Select + Adjust buttons for 3 seconds

- 1.In the main screen, hold the Select+Adjust buttons at the same time for 3 seconds to enter the setting screen.

## 3-4 Main function instruction (Select button)



- In main screen (ODO). Press the Select button one time to enter the Max. record screen.

- Hold the Adjust button for 3 seconds to reset Max. record.



- In Max. record screen. Press the Select button one time to go back to the main screen (ODO).



- Main screen

### 3-5 Main function switch instruction (Adjust button)

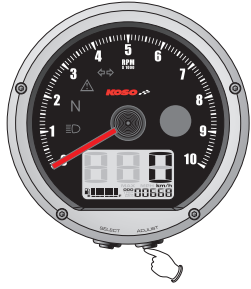

● In main screen (ODO). Press the Adjust button one time to enter the trip A screen.

● Hold the Adjust button for 3 seconds to reset Trip A.

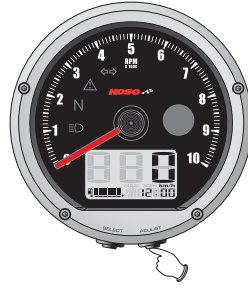

● In the clock screen. Press the Adjust button one time to enter the volt screen.

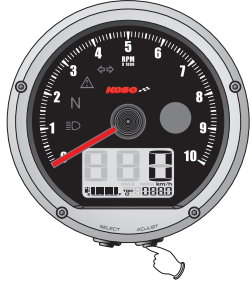

● In Trip A screen. Press the Adjust button one time to enter the trip B screen.

● Hold the Adjust button for 3 seconds to reset Trip B.

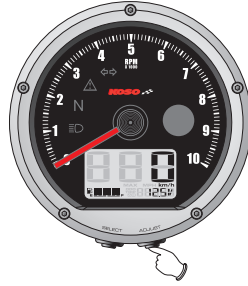

● In the volt screen. Press the Adjust button one time to go back to the main screen (ODO).



● In Trip B screen. Press the Adjust button one time to enter the clock screen.

### 3-6 Setting screen instruction



1. Shift light value setting



2. Shift light flashing ON/OFF



3. Circumference



4. Sensing point



5. Piston numbers



6. Signal type



7. Fuel gauge resistance



8. Clock



9. Backlight brightness



10. Internal ODO display



11. External ODO setting

⚠ The screen will return to the main screen after 30 seconds if no button is press.

## 4 Entering setting screen

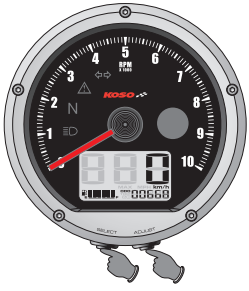

- In the main screen, hold for 3 seconds the Select & Adjust button to enter the setting screen.

### 4-1 Shift light setting



- EX. Set the shift light at 8,500 RPM.
- Press the Select button to move to the digit you want to set.



- Press the Adjust button to change the value.



**Note** Setting range: 1000~10,000 RPM  
Setting unit: 100 RPM



- Press the Select button one time to enter the shift light warning setting screen.
- EX. The shift light is set from 8,000 RPM to 8,500 RPM.

### 4-2 Shift light warning setting

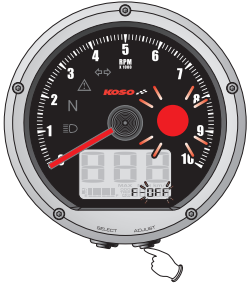

- EX. To set F-ON (Flashing ON) shift light warning.
- Press the Adjust button to change the setting value.

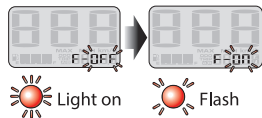

Light on Flash



- Press the Select button once to enter the tire circumference setting screen.
- EX. The shift light warning is set form F-OFF to F-ON.

### 4-3 Tire circumference setting



- EX. If the tire circumference is 1,300 mm.
- Press the Select button to move to the digit you want to set.



- Press the Adjust button to change the value.



**Note** Setting range: 300~2500.  
Setting unit: 1mm

### CAUTION!

- Measure the circumference of tire which the sensor will be installed and keep note of the number of sensor points.
- The speed displayed on the meter will be affected by the setting. Make sure the tire size and the number of sensor point is correct before you set the value.



Use the valve as the starting point to measure the tire circumference. Use a measuring tape to get the distance for one wheel rotation.

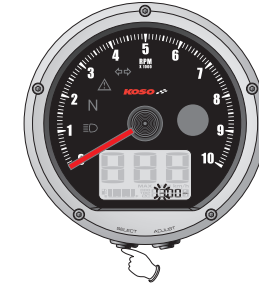

- Press the Select button one time to enter the sensor point setting screen.
- EX. Now the tire circumference is set from 1,000 to 1,300 mm.

### 4-4 Sensor point setting



- EX. If the sensor point is set at 06P.
- Press the Select button to move to the digit you want to set.



- Press the Adjust button to change the value.

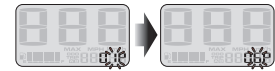

**Note** Setting range: 01P~20P.  
Setting unit: 01P.

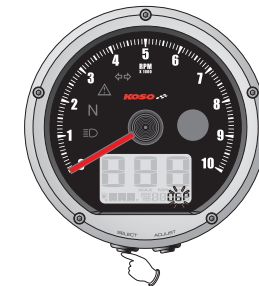

- Press the Select button once to enter the piston numbers setting screen.
- EX. The sensor point is now set from 01P to 06P.

### 4-5 Pistion numbers setting

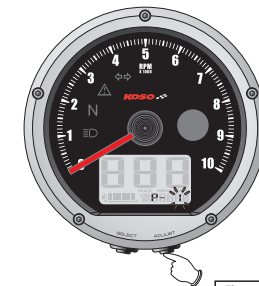

- EX. You want to connect the RPM signal wire to the pick up signal and there are 13 flywheel signals per turn.
- Press the Adjust button to change the value.

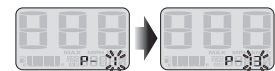

**Note** Setting range: 0.5, 1~24.

The setting value	The corresponding stroke and pistons number.		The corresponding RPM signal number per ignition.
0.5	—	4C-1P	2 RPM signals per 1 ignition.
1	2C-1P	4C-2P	1 RPM signal per 1 ignition.
1.5	—	4C-3P	2 RPM signals per 3 ignition.
2	2C-2P	4C-4P	1 RPM signal per 2 ignition.
2.5	—	4C-5P	2 RPM signals per 5 ignition.
3	2C-3P	4C-6P	1 RPM signal per 3 ignition.
4	2C-4P	4C-8P	1 RPM signal per 4 ignition.
5	—	4C-10P	2 RPM signals per 10 ignition.
6	2C-6P	4C-12P	1 RPM signal per 6 ignition.

**CAUTION!** Most of the 4-cycle bikes with one single piston are igniting every 360 degree once, so the setting should be the same as the bike with 2-cycle and one piston engine.



- Press the Select button once to enter the Signal type setting screen.

#### 4-6 Signal type setting

- EX. Change the setting to Lo.
- Press the Adjust button to change the value.



**Note** We define the RPM input pulse as Hi (Positive pulse) & Lo (Negative pulse.)

**Note** If the RPM displayed on the meter is incorrect, choose another setting and try it again.

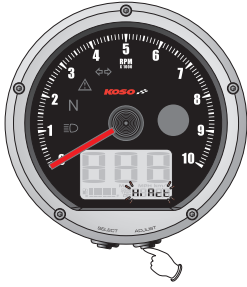

- Press the Select button once to enter the backlight brightness setting screen.
- EX. The clock has been set from 0:00 to 0:05.

#### 4-9 Backlight brightness setting

- EX. Change the brightness to 3-5 (60% brightness.)
- Press the Adjust button to change the value.



**Note** Setting range: 1-5 (Darkest) ~ 5-5 (Brightest), 5 different levels available.  
Setting unit: 20% per level.  
The backlight brightness will change immediately after you set the value.



- Press the Select button once to enter the fuel resistance setting screen.
- EX. The input pulse setting as been changed from Hi to Lo.

#### 4-7 Fuel gauge resistance setting

- EX. The fuel gauge need to be set to 510Ω.
- Press the Adjust button to change the setting.



**Note** The fuel gauge resistance setting range: 100Ω, 250Ω, 510Ω, 1200Ω, SW (turn off).

**Note** When Fuel Setting is set to "SW", the fuel level symbol will light up when fuel level signal wire connected to the negative (-) wire



- Press the Select button once to enter the odometer display screen.
- EX. The backlight brightness has been set from 5-5 to 3-5

#### 4-10 Odometer display

- Press the Select button one time to enter the external odometer setting screen.
- EX. The internal odometer display is 12500 km.



#### 4-11 Odometer display

- EX. Set the odometer to 5000 km (mile).
- Press the Select button to move to the digit you want to set.



- Press the Adjust button to change the value.



- Press the Select button once to enter the clock setting screen.
- EX. The setting has been changed from 1000 to 5100.

#### 4-8 Clock setting

- EX. Set the clock at 0:05.
- Press the Select button to move to the digit you want to set.



- Press the Adjust button to change the value.



**Note** This is a 24 H clock.



- Press the Select button once to go back to the main screen.

- EX. The odometer setting has been changed from 0 to 5,000 km (mile).





● Back to main screen

## 6 Trouble shooting

The following situation do not necessary indicate malfunction of the meter. Please check the following before taking it in for repair.

Trouble	Check item
The meter doesn't work when the power is on.	<ul style="list-style-type: none"> <li>● The power is not supplied properly to the meter.               <ul style="list-style-type: none"> <li>→ Make sure the wiring harness is connected correctly. The wires and fuse might be broken.</li> <li>→ The battery is too old to supply enough DC 12V power to make the meter work.</li> </ul> </li> </ul>
The meter shows wrong information.	<ul style="list-style-type: none"> <li>● Check the voltage of your battery and make sure the voltage is over DC 12V.</li> </ul>
Speed does not appear or appear incorrectly.	<ul style="list-style-type: none"> <li>● Make sure the speed sensor is connected properly.</li> <li>● Check the tire-size setting.               <ul style="list-style-type: none"> <li>→ Refer to the manual 4-3 &amp; 4-4.</li> </ul> </li> </ul>
Tachometer does not appear or appear incorrectly.	<ul style="list-style-type: none"> <li>● Check the RPM wire is connected correctly.</li> <li>● Check if the spark plug is a "R" type. If not, replace the spark plug with the "R" type spark plug.</li> <li>● Check your setting.               <ul style="list-style-type: none"> <li>→ Please refer to the manual 4-4 &amp; 4-6.</li> </ul> </li> </ul>
Fuel gauge does not appear or appear incorrectly.	<ul style="list-style-type: none"> <li>● Check your fuel tank.               <ul style="list-style-type: none"> <li>→ Is there any fuel inside the tank?</li> </ul> </li> <li>● Check the wiring harness.               <ul style="list-style-type: none"> <li>→ Is the wire connected properly?</li> </ul> </li> <li>● Check the setting.               <ul style="list-style-type: none"> <li>→ Refer to the manual 4-7.</li> </ul> </li> </ul>
The clock is incorrect.	<ul style="list-style-type: none"> <li>● Did you connect the wires correctly               <ul style="list-style-type: none"> <li>→ Check the positive wire (Red) connected to the battery, and the main positive wire (Brown) connected to the main switch.</li> </ul> </li> </ul>

※ If still the problem still can't be solve, please contact your local distributor to get assistance.