



• Thank you for purchasing KOSO's TNT-04 meter. Please read the instructions carefully and retain them for future reference.

⚠ Notice

- To avoid a short circuit from occurring do not pull or modify the wires during installation.
- Any damages caused by faulty installation shall be imputed to the users.
- Opening and disassembling this unit will void any warranty.
- Maintenance and repairs should be executed by our professionals only.

○ Symbol description:

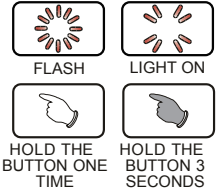











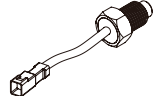



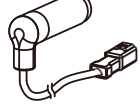

NOTE _____

⚠ Some procedures must be followed in order to avoid faulty installation

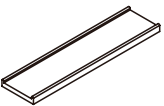
⚠ **Warning!** Some procedures must be followed in order to avoid damages from occurring to yourself and others.

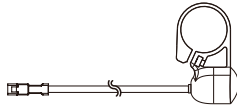

⚠ **Caution!** Some procedures must be followed in order to avoid damages from occurring to the vehicle.

1-1 Accessories

1 LCD Meter X1 	2 TH-01_PT 1/8 Temperature sensor X1 	3 RPM wire (TYPE A) X1 	4 RPM wire (TYPE B) X1 
5 Sensor wire set X1 	6 Active speed sensor X1 	7 M8 / S type speed sensor bracket X1 	8 M10 / S type speed sensor bracket X1 
9 M5X5Lmm Hexagon screw X2 	10 2.5 mm Allen key X1 	11 Meter bracket X1 	12 Handle bar clamp X1 
13 Rubber X1 	14 M6X18L screw X1 	15 M5XP0.8 nut X3 	16 M6XP1.0 nut X1 
17 M5 washer X3 	18 M6 washer X1 	19 External button X1 	

NOTE Contact your local distributor if the items received are not the same as the items listed above.

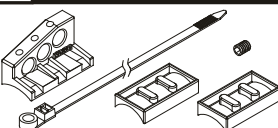
1-2 Optional accessories

1 L TYPE speed sensor bracket 	2 Temperature sensor adapter  M12 X P1.5 X 15L M14 X P1.25 X 15L M14 X P1.5 X 15L M16 X P1.5 X 15L M18 X P1.5 X 15L M20 X P1.0 X 15L M20 X P1.5 X 15L
--	---

NOTE Some of the optional accessories may not be available in your area. Contact your local distributor to obtain more information.

2-1 Wiring installation instructions

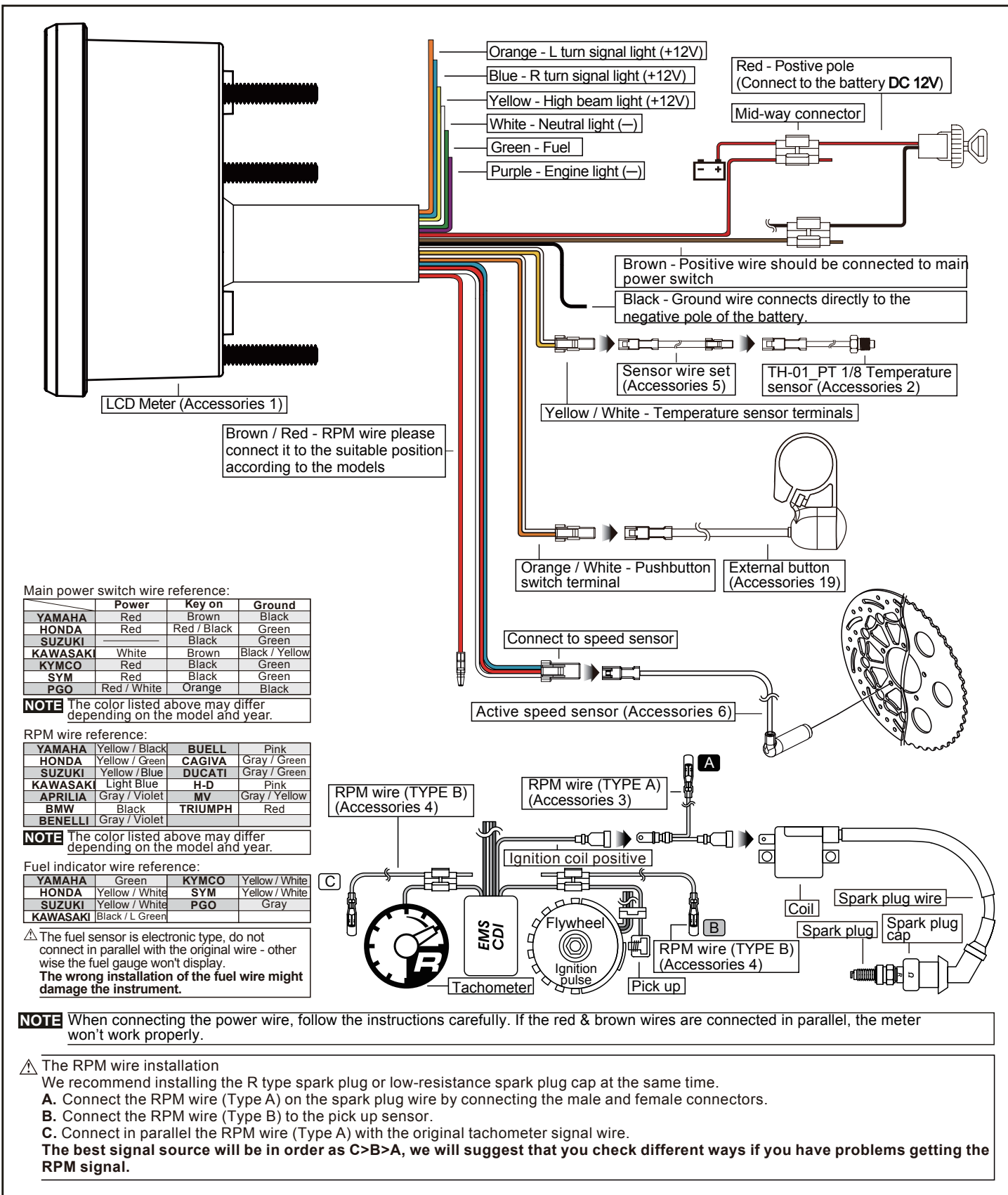

2-2 Installation instructions

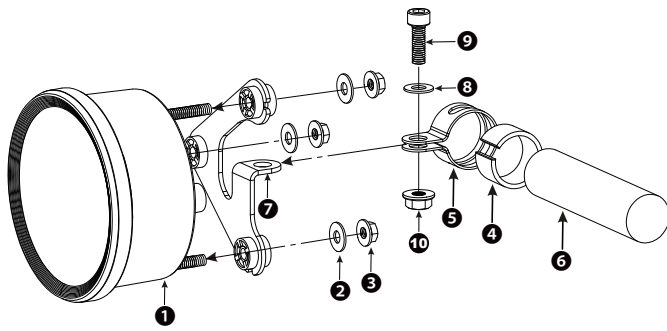

When installing, please follow the steps below.

1. LCD Meter (Accessories 1)
2. M5 washer (Accessories 17)
3. M5XP0.8 nut (Accessories 15)
4. Rubber (Accessories 13)
5. Handle bar clamp (Accessories 12)
6. Bike handle
7. Meter bracket (Accessories 11)
8. M6 washer (Accessories 18)
9. M6X18L screw (Accessories 14)
10. M6XP1.0 nut (Accessories 16)

NOTE Adjust the meter to the proper angle before tightening the handle bar bracket screws.

MOTO / SCOOTER S type speed sensor bracket instructions



Install the s type sensor bracket.

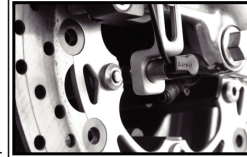

Install the speed sensor on the bracket.

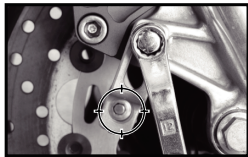

Adjust the sensor bracket position to make sure that the sensor is facing the magnet. This will prevent bad speed signal or no signal from occurring.

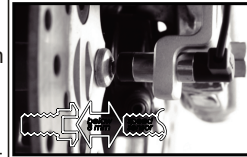

Adjust the distance between sensor and magnet. We suggest you make sure the distance is under **3 mm** for catching good speed signal.

MOTO / SCOOTER L type speed sensor bracket instructions



Install the L bracket and the anti-slip rubber on the front fork and adjust it to the proper height and angle.



Install the speed sensor on the bracket.

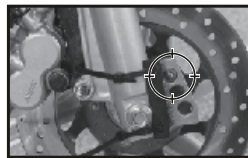

Use the cable tie to fix the bracket on the front fork. Make sure the disc screw could pass the hole on the bracket for you to install the sensor into the same hole to receive the speed signal.

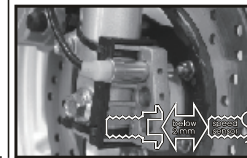

Adjust the distance between sensor and magnet. We suggest that you make sure the distance is under **3 mm** for receiving a good speed signal.

P.S.



The active speed sensor can be installed on the following metal parts, in order to detect the speed.

EX. 1 The disc screw.

EX. 2 The disc to detect the disc gap. (Please make sure the distance between the gaps are the same in advance to avoid wrong speed signal.)

EX. 3 The sprocket to detect the disc gap. (Please make sure the distances between the gaps are the same in advance to avoid wrong speed signal.)

EX. 4 Rear disc - detect the gap between the disc.

We suggest that you use the disc screws as the location for the magnets. You can use 1 or more magnets. Make sure the distance between the magnets are the same. The maximum points that the speed sensor can detect is 20 points per turn.

⚠ After installation, please use your hand to turn the tire to see is everything ok. The LED on the active speed sensor will light up once the signal is detected.

EX. 1

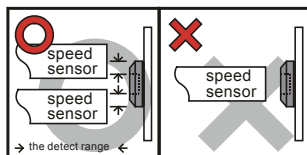

The hexagon socket disc screw
The best detection area: The edge of the hexagon socket screw.

⚠ Don't catch the signal from the middle hole of the hexagon socket screw to avoid wrong signal.

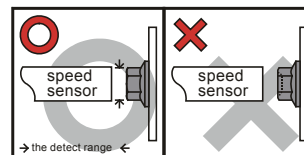

The hexagon screw
The best detection area: The middle of the screws.

⚠ Some hexagon screws have a small hole in the center in this case, we will suggest you to catch the signal from the edge of the screw like the hexagon socket screw.

EX. 2, 4

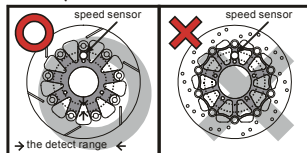

The disc
The best detection area: the gaps of the disc.

⚠ There are certain discs with gaps in different places, and this method will not work on those.

EX. 3

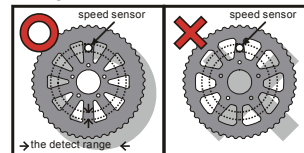

The sprocket
The best detection area: the gaps of the sprocket.

⚠ There are certain sprockets with gaps in different places, and this method will not work on those.

3-1 Basic function instructions



Tachometer
●Display Range : 0 ~ 10,000 RPM

Indicator
●RPM shift light ●Trun signal
●Warning 1 ●High beam light
●Warning 2 ●Engine warning light
●Neutral N

Speedometer
●Display range : 0 ~ 360 km (0 ~ 255 mile)
●Display unit : 1 km (mile)

Millage maintenance user settings (closable)
●Display range : user adjustable (500 ~ 16,000km / 300 ~ 10,000 mile) ~ -999 mile, automatically decreases according to the increase of total millage
●Display unit : 1 km (mile)

Gear meter
●Display range : off, highest gear, N and highest gear, show all (N / 1 ~ 6)

Time
●Display range : 12 / 24 hour format

Fuel meter
●Display Range : 6 Levels

Engine temperature
●Setting range : -40 ~ 215°C (-40 ~ 419 °F)

Odometer
●Display range : 0 ~ 999,999 km (mile) return to zero upon exceed
●Display unit : 1 km (mile)

Distance meter A,B
●Display range : 0 ~ 9,999.9 km (mile) returns to zero upon exceed
●Display unit : 1km (mile)

Voltmeter
●Display range : 8 ~ 18 V

3-2 Function settings instructions

●Speedometer	Display range : 0 ~ 360 km (0 ~ 255 mile) switchable Display unit : 1 km (mile)	●RPM shift light, Warning 1, Warning 2	○Warning cause	Overspeed, over rpm, overheat, under voltage, low fuel, reached motor oil maintenance millage, maximum gear level
○Speedometer unit	Display range : km, mile	○Warning method	Lit.(L), Slow flash(S), Flash(F)	
○Over speed warning	Setting range : 30 ~ 360 km (19 ~ 225 mile), warning sign will be given once exceed(include) setting value. Setting unit : 1km(mile)	●Fuel meter	100Ω、250Ω、270Ω、510Ω、1200Ω、fuel switch、USER	
○Display interval	<0.5 second	●Clock	Setting range : 12 / 24 hour format	
○Tire circumference	Display range : 300 ~ 2,500 mm Setting unit : 1 mm	●Voltmeter	Display range : 8 ~ 18 V	
○Sensitive point	Display range : 1 ~ 20 point Setting unit : 1 point	●Under voltage warning	Setting range : 8.0 ~ 18.0 V, warning sign will be given once below(include)setting value.	
○Internal and external odometer	Display range : 0 ~ 999,999 km (mile) return to zero upon exceed Display unit : 1 km (mile)	●Backlight brightness	Setting range : 1 / 5 (darkest) ~ 5 / 5 (brightest)	
○Trip meter A,B	Display range : 0 ~ 9,999.9 km (mile) returns to zero upon exceed Display unit : 0.1 km (mile)	○Backlight color	Setting range : red, orange, yellow, green, blue, light blue, purple, white	
●Gear meter	Display range : off, highest gear, N and highest gear, show all (N / 1 ~ 6)	●Maintenance millage	Setting range : OFF, 500 ~ 16,000 km (300 ~ 10,000 mile) Setting unit : 100 km (mile)	
●Tachometer	Display range : 0 ~ 10,000 RPM	○Operating voltage	DC 8V to DC 16V	
○RPM signal	Display range : P-0.5, P-1 ~ P-24	●Temperature range	-10 ~ +60°C	
○The RPM input pulse	Display range : Hiact, Loact	○Specifications	JIS D 0203(S2)	
○Over RPM warning	Setting range : 1,000 ~ 10,000 RPM, warning sign will be given once exceed(include) setting value. Setting unit : 100 RPM	●Meter Size	D 94.7 X 55.8 mm	
●Thermometer	Display range : 0 ~ 250 °C (32 ~ 482 °F)	○Meter Weight	165 g	
○Thermometer unit	Display unit : °C, °F	●Indication light	●RPM shift light ●Trun signal ●Warning 1 ●High beam light ●Warning 2 ●Engine warning light ●Neutral N	
○Over temp warning	Setting range : 60 ~ 250 °C (140~ 482 °F), warning sign will be given once exceeding the setting value. Setting unit : 1 °C (°F)			

NOTE Design and specification may change without further notice.

3-3 Main menu functions



- In the total millage screen, press the **button once** to switch to Trip A screen.
- Hold the **button for 3 seconds** to enter into the settings screen.



- Trip A screen, Press the **button once** to switch to Trip B screen.
- Hold the **button for 3 seconds** to clear the Trip A recordings.





- Trip B screen, press the **button once** to switch to the millage maintenance screen.

- Hold the **button for 3 seconds** to clear the Trip B recordings.



- In the millage maintenance screen, press the **button once** to switch to the clock screen.

- Millage maintenance will count down from setting value, when it reaches 0, the screen will blink to indicate the millage reached.



- Hold the **button for 8 seconds** to clear the millage maintenance recordings.



- In the 0 second, start holding the button.



- In the 3rd second, the inform feature will blink once.

- During the 4 ~7 the seconds, if you release the button it will cancel the process.



- On the 8 th second, the millage maintenance record is cleared.



- In the clock screen, press the **button once** to switch to the temperature screen.



- In the temperature screen, press the **button once** to switch to the voltage screen.



- In the voltage screen, press the **button once** to switch to the Max. Speed Record display screen.

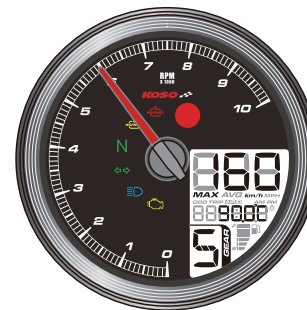

- In the Max. Speed record display screen, press the **button once** to return to the millage screen.

- Hold the **button for 3 seconds** to clear the Max. Speed Record display.

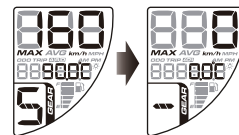

4 Gear level learning settings

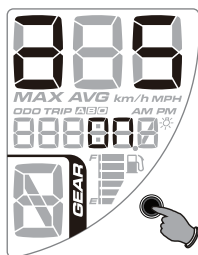

- In gear learning screen, press and hold the **SELECT button for 3 seconds** to enter settings screen.

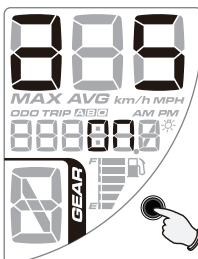

- Press the **SELECT button once** to choose turn on or off the gear indicator display.

NOTE If any changes happen to tires circumference then the gear indicator will need to re-learn the gear positioning.

NOTE Setting range : ON \ OFF ◦

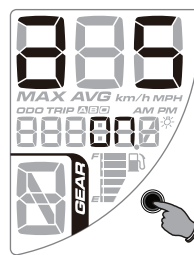

- When gear level display is "ON", hold the **SELECT button** for 3 seconds to enter gear level learning screen.
- When gear level display is "OFF", hold the **SELECT button** for 3 seconds to return to gear level learning setting screen.
- EX. Setting gear display from "OFF" to "ON".

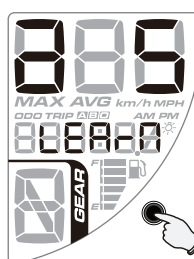

- EX. When chronograph display LEARN, it will blink.
- Press the **SELECT button once** to start the gear learning.

Note Press and hold the **SELECT button for 3 seconds** to quit the learning and return to the previous screen.

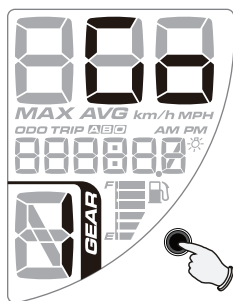

- Start the riding when "GO" is flashing.
- Press the **SELECT** button once to start the gear learning.

Note Press the **SELECT** button to quit the learning and return to the previous screen.

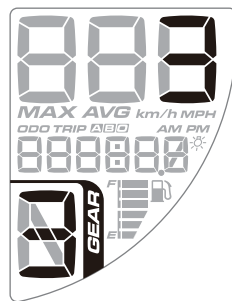

- When the number 3 is flashing, put the motorcycle in 3rd gear and start riding slowly until the meter detects the correct gear. Once the meter has detected 3rd gear, the screen will automatically switch to number 4.

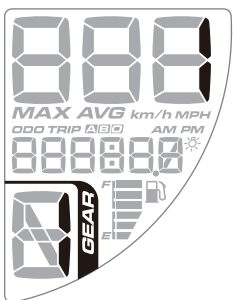

- When the number 1 is flashing, put the motorcycle in 1st gear and start riding slowly until the meter detects the correct gear. Once the meter has detected 1st gear, the screen will automatically switch to number 2.

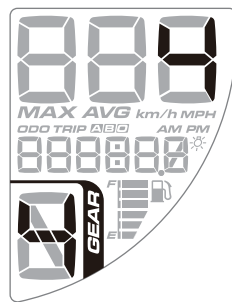

- When the number 4 is flashing, put the motorcycle in 4th gear and start riding slowly until the meter detects the correct gear. Once the meter has detected 4th gear, the screen will automatically switch to number 5.

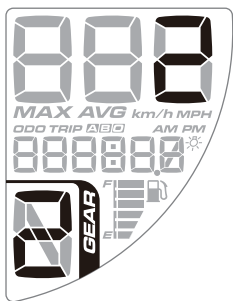

- When the number 2 is flashing, put the motorcycle in 2nd gear and start riding slowly until the meter detect the correct gear. Once the meter has detected the 2nd gear, the screen will automatically switch to number 3.

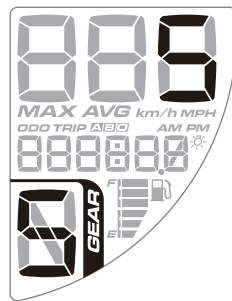

The main screen now displays the number 5, slow down and wait until the meter goes back to the main screen.

5 Troubleshooting

The following situations do not indicate malfunction of the meter. Check the following points before taking it in for repairs.

Trouble	Check item	Trouble	Check item
The meter doesn't work when the power is on.	<ul style="list-style-type: none"> • The power doesn't supply to the meter. →Make sure the wiring is connected. The wiring and fuse are not broken. →The battery is broken or the battery is too old to supply enough power (DC 8 V) to make the meter work. • Check the voltage of your battery, and make sure the voltage is over DC 8 V. 	The odometer and trip meter are not accumulating data or accumulated the wrong data.	<ul style="list-style-type: none"> • It is possible that the permanent power wire is not connected properly. →Check if the red positive wire is properly or not.
The meter shows the wrong information.	<ul style="list-style-type: none"> • Make sure the speed sensor is connected properly. →Please check if speed sensor is connected and working properly. Also check whether the cable of speed sensor is broken or lose. 	Fuel gauge does not appear or appears incorrectly.	<ul style="list-style-type: none"> • Check your fuel tank. • Check the wiring harness. ☒Is the wire connected properly.
Speed does not appear or appears incorrectly.			

* If the problem is not resolved after following the steps shown above, contact your local distributor for assistance.