



# YOSHIMURA

RESEARCH & DEVELOPMENT OF AMERICA, INC.

5420 DANIELS STREET STE A, CHINO CA. 91786 · (800)634-9166 · (909)628-4722 · FACSIMILE (909)591-2198

[www.yoshimura-rd.com](http://www.yoshimura-rd.com)

## RS-5 PERFORMANCE EXHAUST SYSTEM

**HONDA  
2004-2007  
CBR1000RR**

**120022 (2,5,7)**

RACE ONLY STAINLESS STEEL SLIP ON SYSTEM

**120027 (2,5,7)**

RACE ONLY STAINLESS STEEL SLIP ON SYSTEM WITH CONE CAP

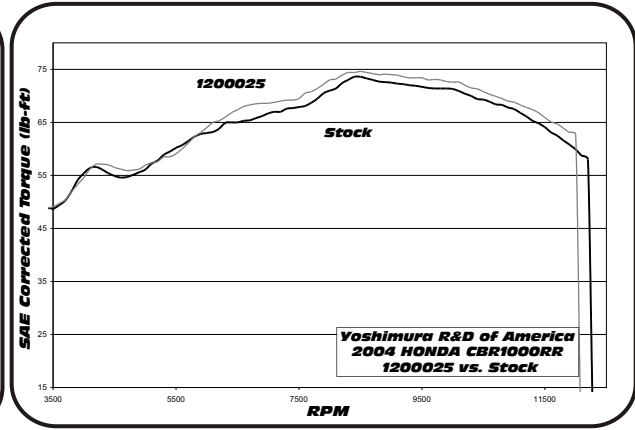
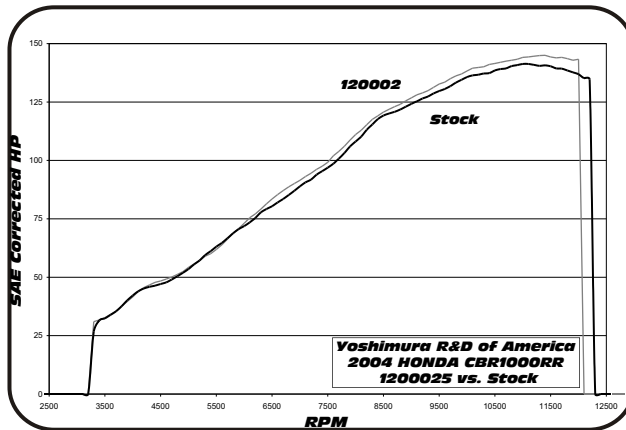

Note: Dyno graphs are for comparison use only. Actual results may vary depending on operating and motorcycle condition.



**THIS PRODUCT IS DESIGNED FOR USE IN CLOSED COURSE RACING AND IS NOT INTENDED FOR HIGHWAY USE.**



NOTE: IN THE STATE OF CALIFORNIA, IT IS ILLEGAL TO MODIFY THE EMISSION CONTROL SYSTEM, WHICH INCLUDES THE CARBURETORS OF ANY VEHICLE.

**Caution:** Exhaust system can be extremely hot. Let motorcycle cool down before beginning installation.

**Note:** Read through all instructions before beginning installation.

## Tools Needed:

8mm, 11mm, 12mm, 13mm sockets

Ratchet Wrench

12mm wrench

5mm, 8mm Allen wrench

Phillips screwdriver

Torque wrench

Sharp Scissors & Pen

## Installation Steps:

- 1 Remove rider seat (2 bolts under rear edges of seat) and passenger seat.
- 2 Remove rear cowling: Remove 4 bolts (See Fig. 1), pull cowling toward rear of bike and up (inner taillight bolts seat into rubber grommets on rear of subframe). Carefully pry right side of cowling over frame, then left side. Disconnect tail light connector (located in trunk) and remove cowling.
- 3 Unbolt and remove rear turn signal and fender assembly: rear turn signal connectors (on left rear side) must be disconnected prior to removing fender assembly. (Fig. 2)
- 4 Disconnect Tailpipe exhaust valve cables (Fig.3) (See Service Manual for complete removal of cables or you may simply zip tie cables to a secure location) Note: do not disconnect Servo motor from ECU.
- 5 Remove right side passenger foot peg, black plastic heatshield, right side footpeg assembly, and tailpipe heat shield. (Fig. 4)
- 6 Loosen muffler mounting bolts (do not remove). Loosen stock chassis mount bolt (do not remove). Loosen tailpipe to header collector clamp. While supporting muffler/tailpipe assembly (it's heavy) remove chassis mount bolt then muffler support bracket bolt and nut. Remove stock tailpipe, muffler, stock tailpipe gasket, and clamp ring. (Fig.5)

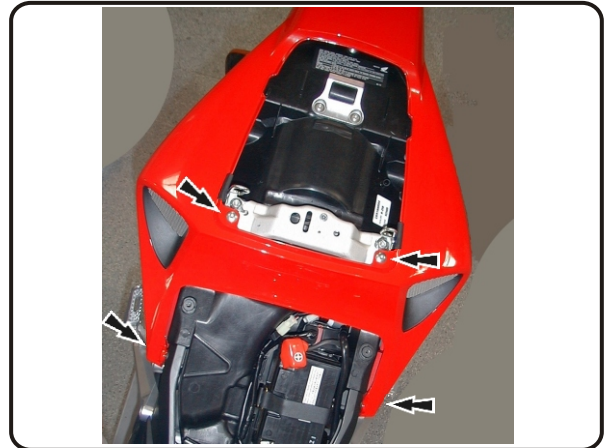

Fig. 1

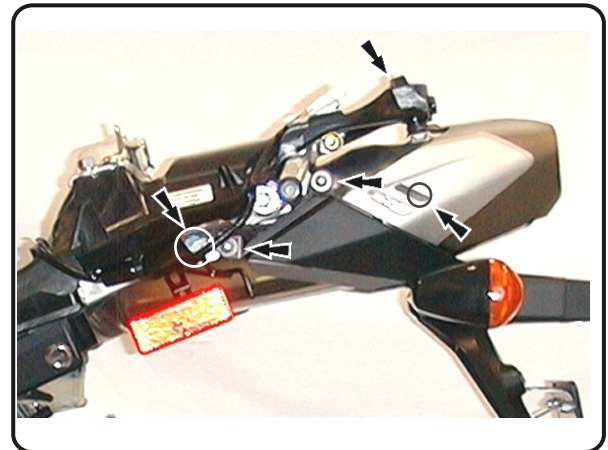

Fig. 2



Fig. 3



Fig. 4

- 7 Remove stock under tail heatshield (Fig.6)
- 8 Install adhesive heatshield to rear under tail section. (See Page 4 for instructions)
- 9 Slip supplied collector clamp over Yoshimura tailpipe and slide tailpipe onto stock header. Install stock chassis mount bolt loosely to hold tailpipe in place.

**2006 AND NEWER MODELS ONLY:** In order to use the supplied 8mm bolt and washer for the tailpipe mount on 2006 and newer models, the rubber grommet and steel insert must be moved from the stock muffler mount location replacing the stock 6mm chassis mount rubber grommet and steel insert (See Fig. 7 for grommet and insert locations). Once the rubber grommet and steel insert are switched, use the supplied 8mm x 40mm bolt, washer and nut to install the tailpipe. The stock muffler mounting points will NOT be used to mount the Yoshimura muffler.

- 10 Install supplied muffler clamp heatshield to inside of muffler clamp. Slide muffler clamp onto muffler and line up muffler clamp ears with the center mounting location. Install stock nut and supplied bolt on clamp - leave loose at this time. (Fig.8)
- 11 Check alignment of exhaust, then torque collector clamp to 1.25 kg-m (9 lb-ft).
- 12 Torque muffler clamp bolt and nut to 2.5 kg-m (18 lb-ft).
- 13 Torque chassis mount bolt to 2.5 kg-m (18 lb-ft).
- 14 Re-install rear fender, seat cowling, foot peg and seat in reverse order of disassembly. Check for proper operation of tail light, brake light, and turn signals before completion.
- 15 It is recommended that the muffler and tailpipe be wiped down with rubbing alcohol to remove oil and fingerprints. This will help prevent tarnishing of the finish after the exhaust is heated up.
- 16 Check for proper clearance between new exhaust system and motorcycle. (i.e. Swing-arm, body work, etc.) If any problem is found, please carefully follow through the installation steps again. If problem still persists, please call Yoshimura tech. dept. at  
(800)634-9166 / in CA (909)628-4722



Fig. 5

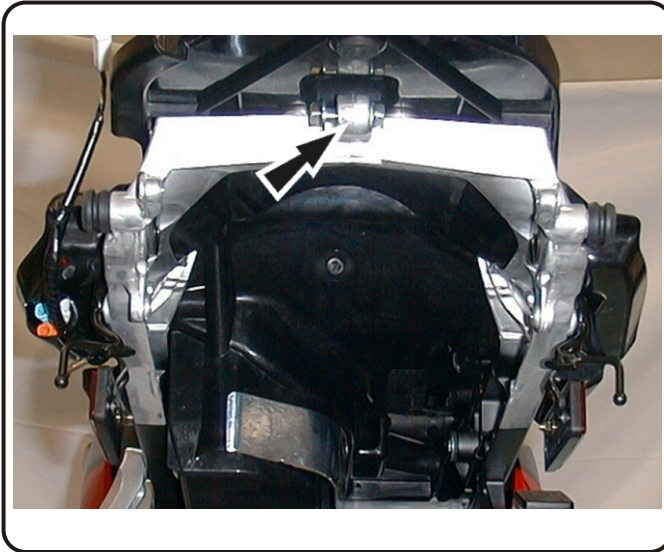

Fig. 6



Fig. 7

**Note:** After starting motorcycle, it is normal for new exhaust system and muffler to emit smoke until oil residue burns off.

**Fig. 8**

- 1 *Cut out supplied template #1 (mark template side as up in accordance with diagram).*
- 2 *Tape or firmly hold template to adhesive side (not foil side) of heatshield.*
- 3 *Trace outline of template on heatshield.*
- 4 *Use scissors to cut heatshield to outline. When cutting keep excess trimmings in one piece - the extra piece will be used later.*
- 5 *Use rubbing alcohol to clean area where heatshield will be applied.*
- 6 *Remove adhesive backing and apply to underside of rear fender assembly.*

*Note: Start by installing right side of the heatshield all the way forward. Then work to the left ensuring no air bubbles exist.*

**Fig. 9**

- 7 *Cut out supplied Template #2 and repeat process.*
- 8 *After both pieces of the heatshield are installed, use remainder of heatshield to patch or cover any open areas.*

**#120022(2,5,7) / 120027(2,5,7)**

**2006-2007 Models Only:  
Use supplied 8mm x 40mm  
bolt and supplied 8mm  
washer for tailpipe mount.**

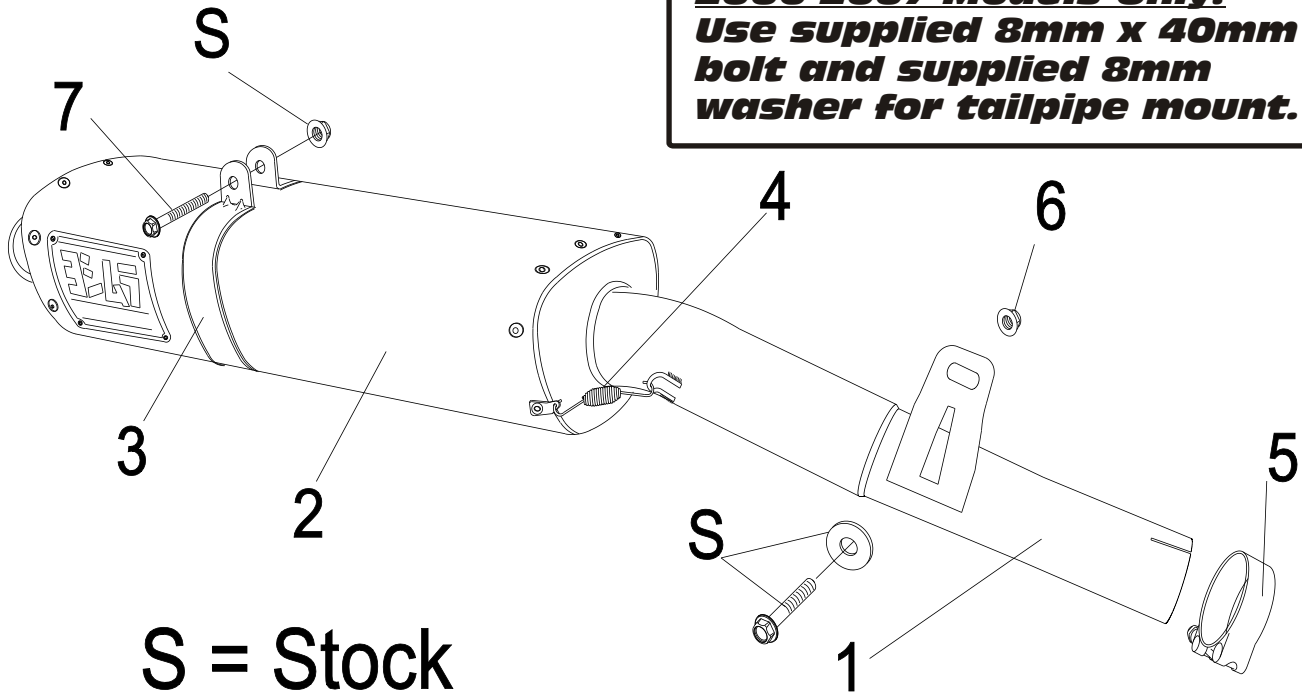

**S = Stock**

Parts Diagram

NO.	DESCRIPTION	QTY	PART #
1	Yoshimura Stainless Steel tailpipe	1	1200-435
2	RS-5 Muffler Assembly	1	**
3	Muffler Clamp for SS/Ti	1	CHS500S8ASX
	Muffler Clamp for CF	1	CHS500S8AS
4	2.5" Exhaust Spring	2	RACE-SPS
5	Stainless Steel Collector Clamp	1	200-60
6	8mm Nut	1	8MMNUT
7	8mm x 30mm Bolt	1	M8X30H
**	Adhesive Back Foil Heatshield (8" X 16")	1	1200-00-01
**	Muffler Clamp Heat Insulator	1	HT SHLD5
**	Yoshimura Vinyl Sticker	2	17028-BLK
**	Foil Heatshield Template	1	**
**	8mm x 40mm Bolt (2006-2007 Model Only)	1	M8X40H
**	8mm Washer (2006-2007 Model Only)	1	8MMWASHERL

**Nuts and Bolts Guide (Actual Size):**

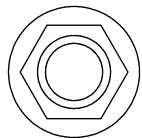

8mm Flange Nut

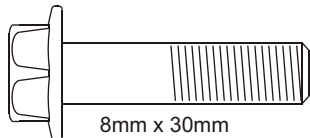

8mm x 30mm  
Flange Hex Bolt



8mm x 40mm  
Flange Hex Bolt

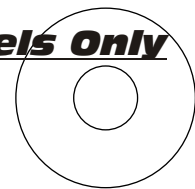

8mm Large Washer

**For 2006 Models Only**