



## GEN II CANsmart™ Controller

DNL.WHS.11602  
BMW R1200 Liquid Cooled Series



[DENALIElectronics.com/BMW-CANsmart-User-Guide](http://DENALIElectronics.com/BMW-CANsmart-User-Guide)

### Thank you for choosing DENALI

We know you would rather be riding your bike than wrenching on it, so we go the extra mile to make sure our instructions are clear and as easy to understand as possible. If you have any questions, comments, or suggestions don't hesitate to give our experts a call at 401.360.2550 or visit [WWW.DENALIELECTRONICS.COM](http://WWW.DENALIELECTRONICS.COM)

### Please Read Before Installing

DENALI products should always be installed by a qualified motorcycle technician. If you are unsure of your ability to properly install a product, please have the product installed by your local motorcycle dealer. DENALI takes no responsibility for damages caused by improper installation. **Caution:** When installing electronics it is extremely important to pay close attention to how wires are routed, especially when mounting products to the front fender, front fork, or fairing of your motorcycle. Always be sure to turn the handlebars fully left, fully right, and fully compress the suspension to ensure the wires will not bind and have enough slack for your motorcycle to operate properly.

### Installation Tips

We strongly recommend using medium strength liquid thread locker on all screws and bolts. It is also important to ensure that all hardware is tightened to the proper torque specifications as listed in your owner's manual. For included accessory hardware please refer to the default torque specifications provided below. Inspect all hardware after the first 30 miles to ensure that proper torque specifications are maintained.

Bolt Size	in-lbs	ft-lbs	Nm
M3	10.0 in-lbs	-	1.0 Nm
M4	23.0 in-lbs	-	2.5 Nm
M5	44.5 in-lbs	3.5 ft-lbs	5.0 Nm
M6	78.0 in-lbs	6.5 ft-lbs	9.0 Nm
M8	-	13.5 ft-lbs	18.0 Nm
M10	-	30.0 ft-lbs	41.0 Nm
M12	-	52.0 ft-lbs	71.0 Nm

### Hardware Sizing Guide

Not sure what size bolt you have? Use this ruler to measure screws, bolts, spacers, etc. Remember, the length of a screw or bolt is measured from the start of the "mounting surface" to the end of the screw, so only include the screw head when measuring countersunk screws.

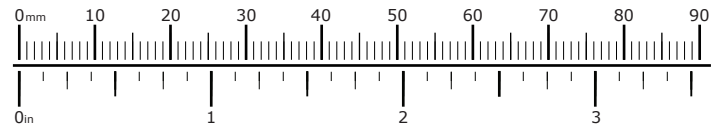

## What's In The Box?

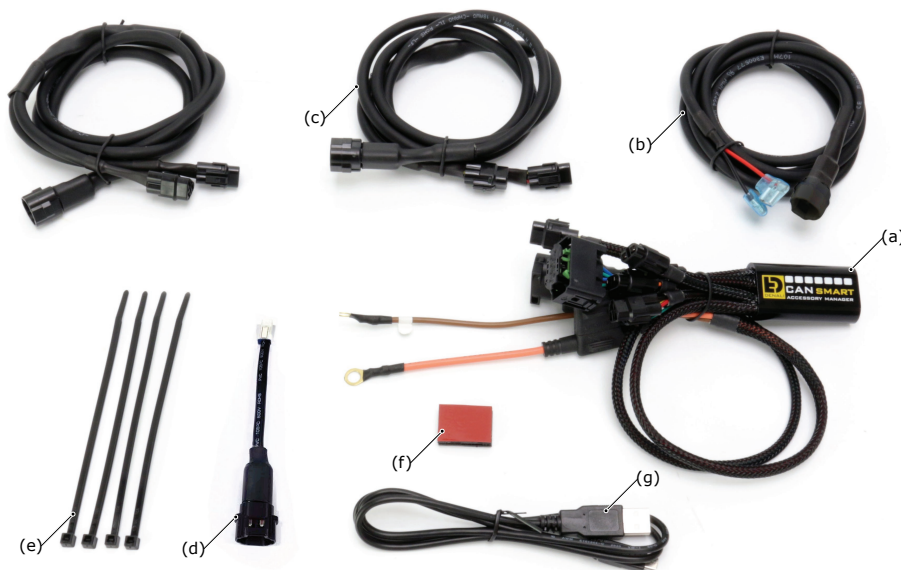

### Kit Contents

- (a) CANsmart™ Controller.....Qty 1
- (b) 3-Pin 5ft Horn Extension.....Qty 1
- (c) 3-Pin 5ft LED Light Extension.....Qty 2
- (d) 3-Pin Brake Light Wiring Adapter.....Qty 1
- (e) Zip Tie.....Qty 4
- (f) Adhesive Dual Lock.....Qty 1
- (g) USB to Micro USB Programming Cable.....Qty 1

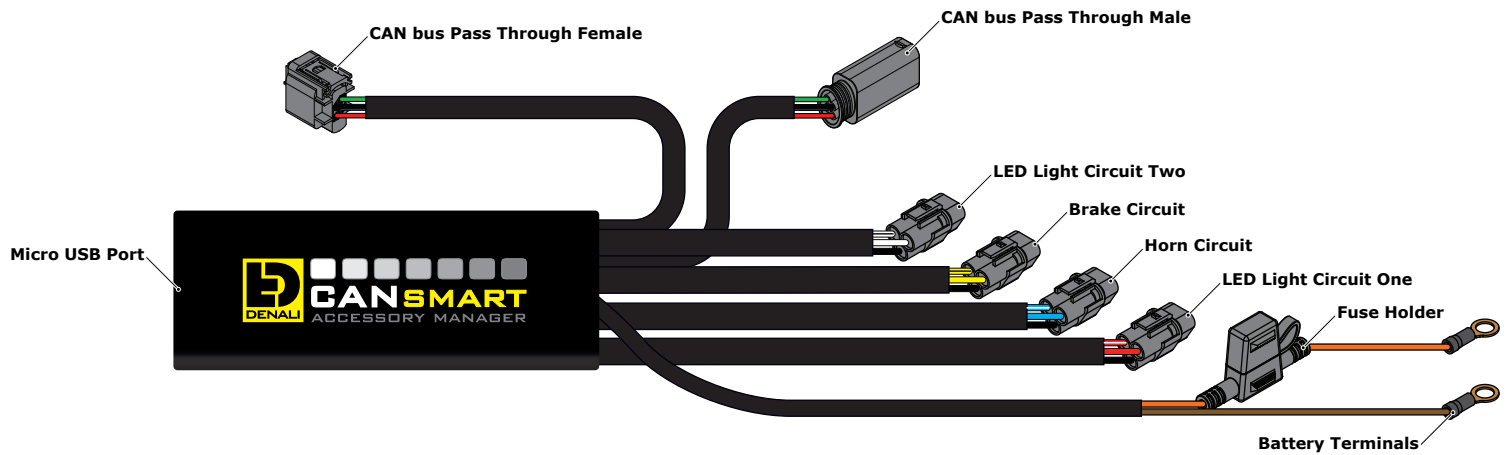

## 1.1 - Overview of Device

The DENALI CANsmart™ Controller provides plug-n-play installation and integrated control of up to four accessories to enable dozens of customizable settings that can be controlled right from the BMW Multi Controller or the CANsmart™ Accessory Manager Software.

The four circuits are pre-programmed to connect and independently control two sets of DENALI 2.0 lights, a SoundBomb horn, and our B6 auxiliary brake light. However, our Circuit Function Selector in the CANsmart software will let you run any accessory of your choice on any of the four circuits.

The illustration above depicts the preprogrammed default configuration, to see all available circuit functions and settings please refer *Section 6* or visit our online user guide at: [DENALIElectronics.com/cansmart-user-guide](http://DENALIElectronics.com/cansmart-user-guide)

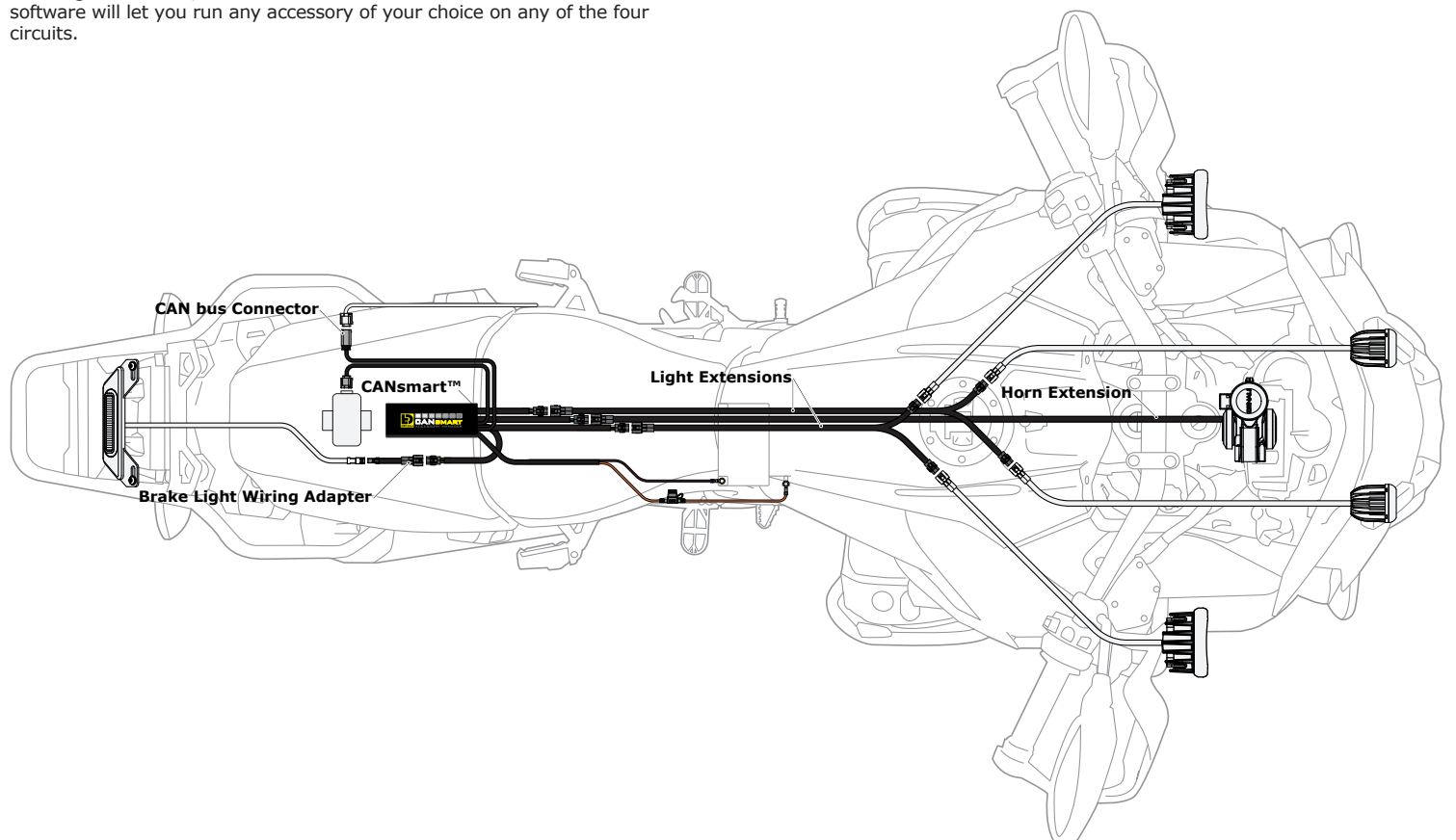

## 1.2 - Overview of System Features

The two auxiliary light circuits enable independent adjustment of high and low beam brightness right from the vehicle's "WonderWheel". It also features a "flash to pass" and "strobe when horn active" setting that will strobe the auxiliary lights when you pulse your high beam switch or sound your horn.

The feature-rich brake light circuit will transform a simple 2-wire brake light into a "smart brake light" complete with running light, multiple flash patterns, and deceleration activated braking functionality.

The horn circuit enables the addition of an auxiliary horn without having to add a relay and dedicated horn wiring harness.

For a full list of features and available settings refer to *Section 6*.

## 2. Connecting To CAN bus

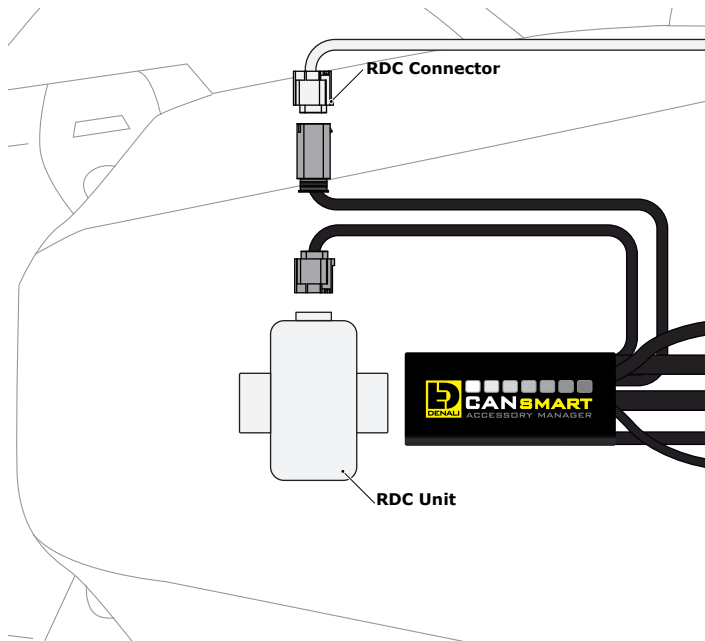

### 2.1 - Bikes With Tire Pressure Monitoring

**Step One:** The RDC unit is located at the rear of the motorcycle in the compartment behind the passenger seat. Remove the seat and body panels in this area to gain access to the unit.

**Step Two:** Unplug the connector from the RDC unit.

**Step Three:** The CANsmart™ Controller plugs in-line between the motorcycle's harness and the RDC unit. First plug the RDC connector into the male 4-pin connector on the CANsmart™ Controller.

**Step Four:** Plug the female 4-pin connector on the CANsmart™ Controller into the RDC unit.

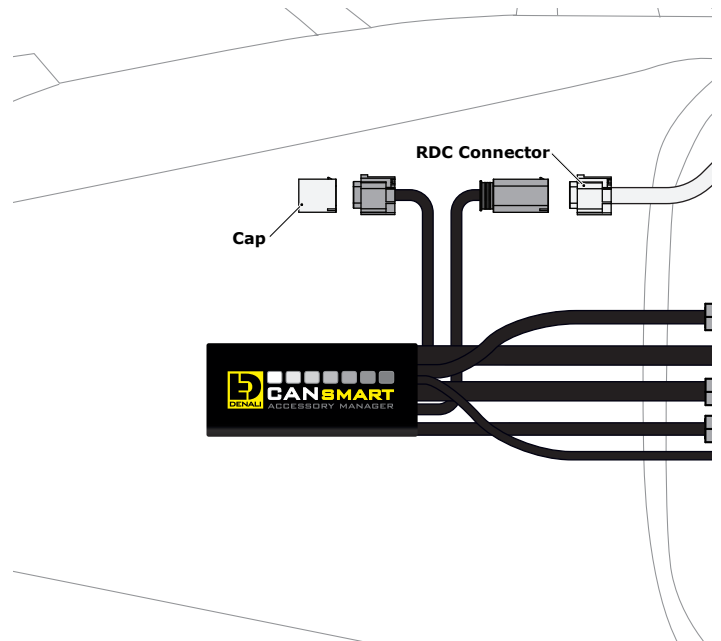

### 2.2 - Bikes Without Tire Pressure Monitoring

**Step One:** The RDC connector is located at the rear of the motorcycle in the compartment behind the passenger seat. Remove the seat and body panels in this area to gain access to the connector.

**Step Two:** Remove the cap from the RDC connector.

**Step Three:** Plug the RDC connector into the male 4-pin connector on the CANsmart™ Controller.

**Step Four:** Use the cap that was previously removed to cover the unused female 4-pin connector on the CANsmart™ Controller.

## 3. Connecting Accessories

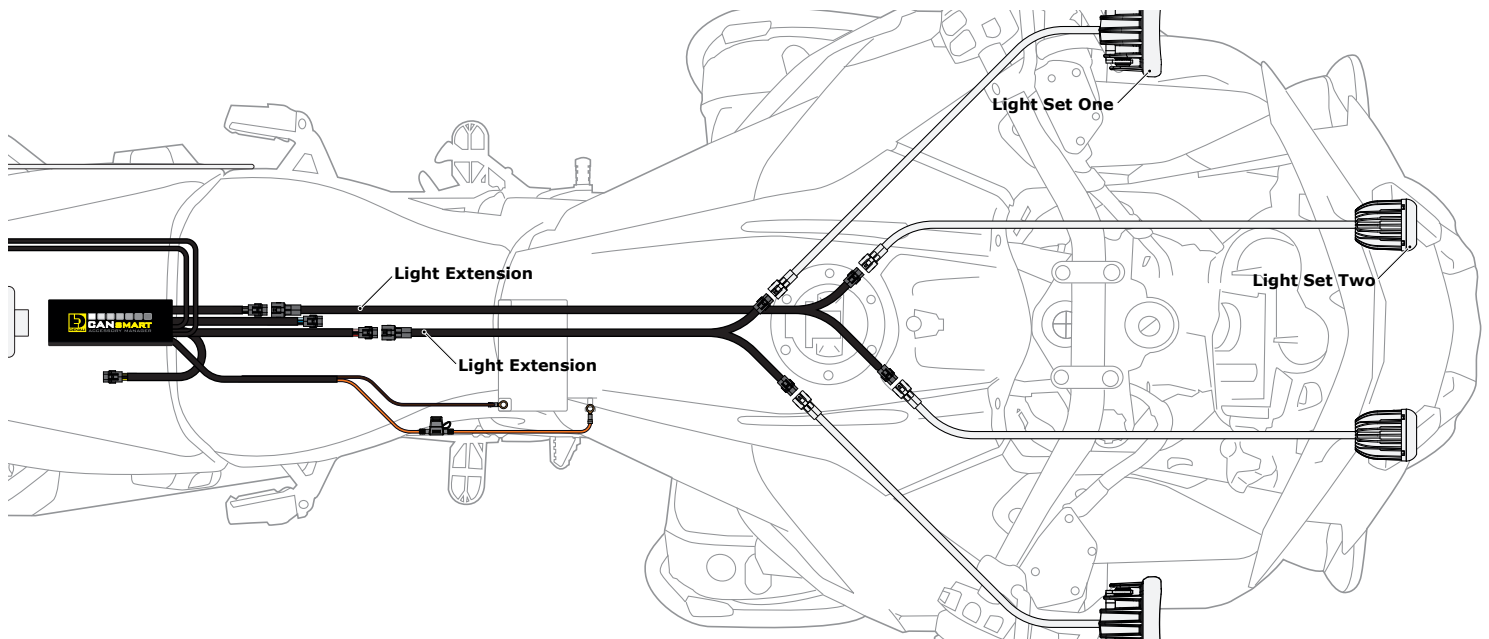

### 3.1 - Light Set One & Two (Red & White Circuits)

In the default configuration, the circuit for Light Set One is the longest red lead, the shortest white lead is for Light Set Two. Both circuits are designed to handle up to 10 amps each.

**Step One:** Plug the male 3-pin connector of the Light Extension-Splitter into one of the CANsmart™ Controller's light circuits.

**Step Two:** Begin routing the harness toward the front of the bike. Secure the harness to the vehicle's frame along the way with the included zip ties. Be sure to avoid any moving components such as radiator fan blades or suspension.

**Step Three:** Plug the DENALI Light Pods into the female 3-pin connectors of the Extension-Splitter. Repeat steps *One* through *Three* using a second Light Extension-Splitter for the second set of lights.

**Two-Wire Dimming:** Turn off "Three-Wire Dimming Mode" for correct dimming operation of auxiliary LED lights that have only two wires. If enabled the 3rd yellow wire will be deactivated and PWM data will instead be transmitted through the red wire.

Wire two wire lights using the red wire for positive (+) and the black wire for negative (-).

# 3. Connecting Accessories (continued)

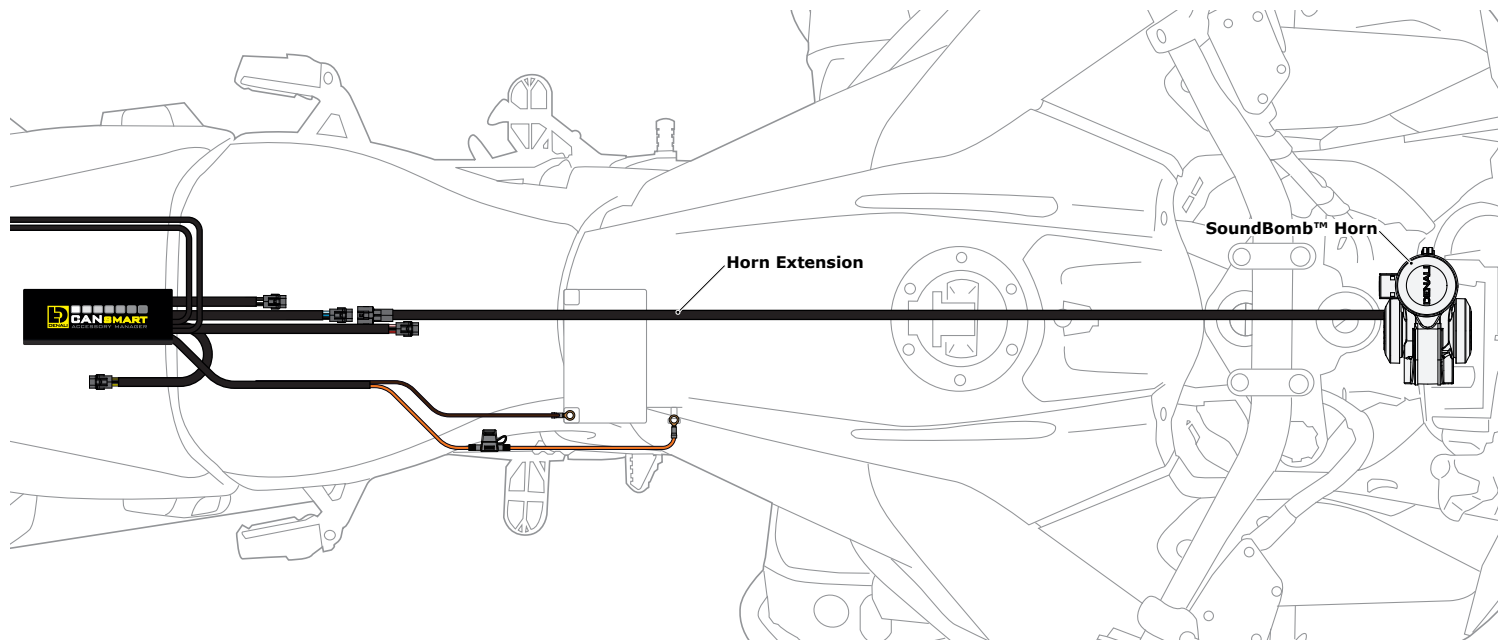

## 3.2 - Horn (Blue Circuit)

**Step One:** Plug the male 2-pin connector of the Horn Extension into blue horn circuit on the CANsmart™ Controller.

**Step Two:** Begin routing the harness toward the front of the bike. Secure the harness to the vehicle's frame along the way with the included zip ties. Be sure to avoid any moving components such as radiator fan blades or suspension.

**Step Three:** Plug the spade connectors of the Horn Extension into the DENALI SoundBomb Horn. The Green wire connects to the positive (+) terminal on the horn, the Black wire goes to the negative (-) terminal.

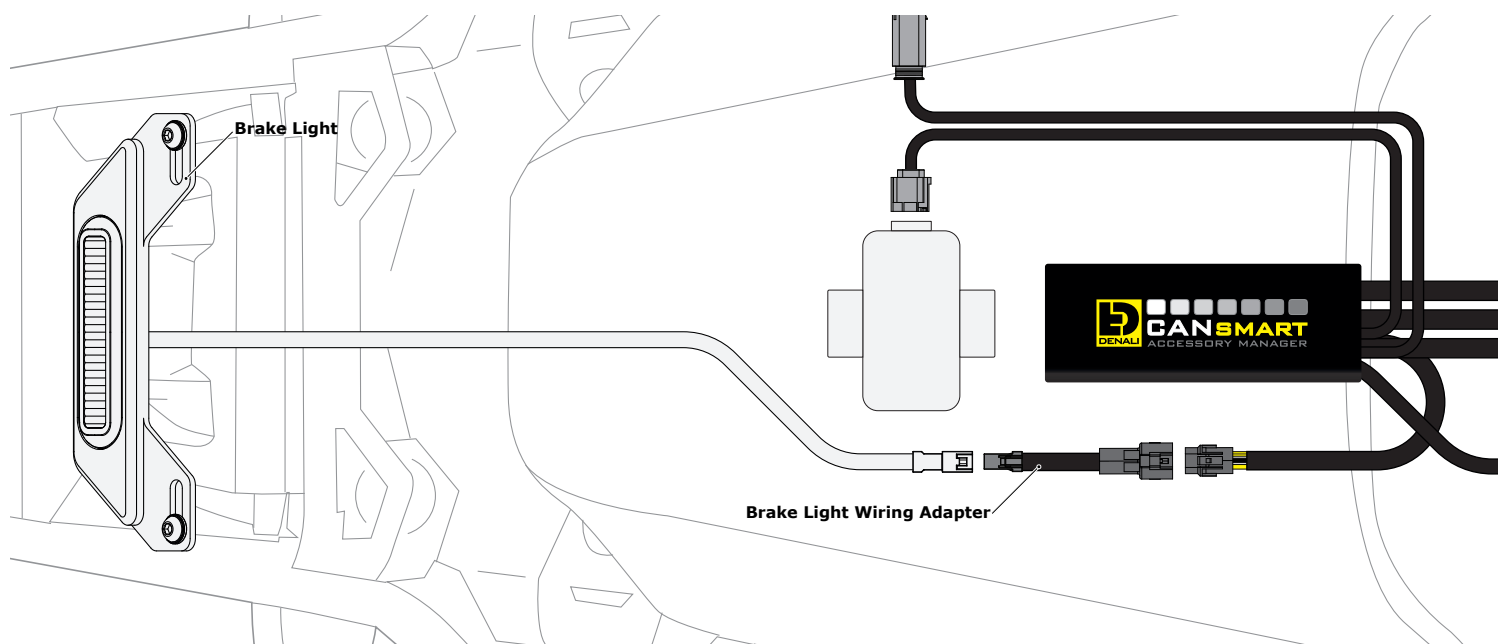

## 3.3 - Brake Light (Yellow Circuit)

**Step One:** Route the harness of the DENALI B6 Brake Light from the rear of your motorcycle toward the CANsmart™ Controller.

**Step Two:** Plug the Brake Light Pigtail into the connector on the DENALI B6 Brake Light.

**Step Three:** Plug the male 2-pin connector of the Brake Light Pigtail into the yellow brake light circuit on the CANsmart™ Controller.

# 4. Connecting To The Battery

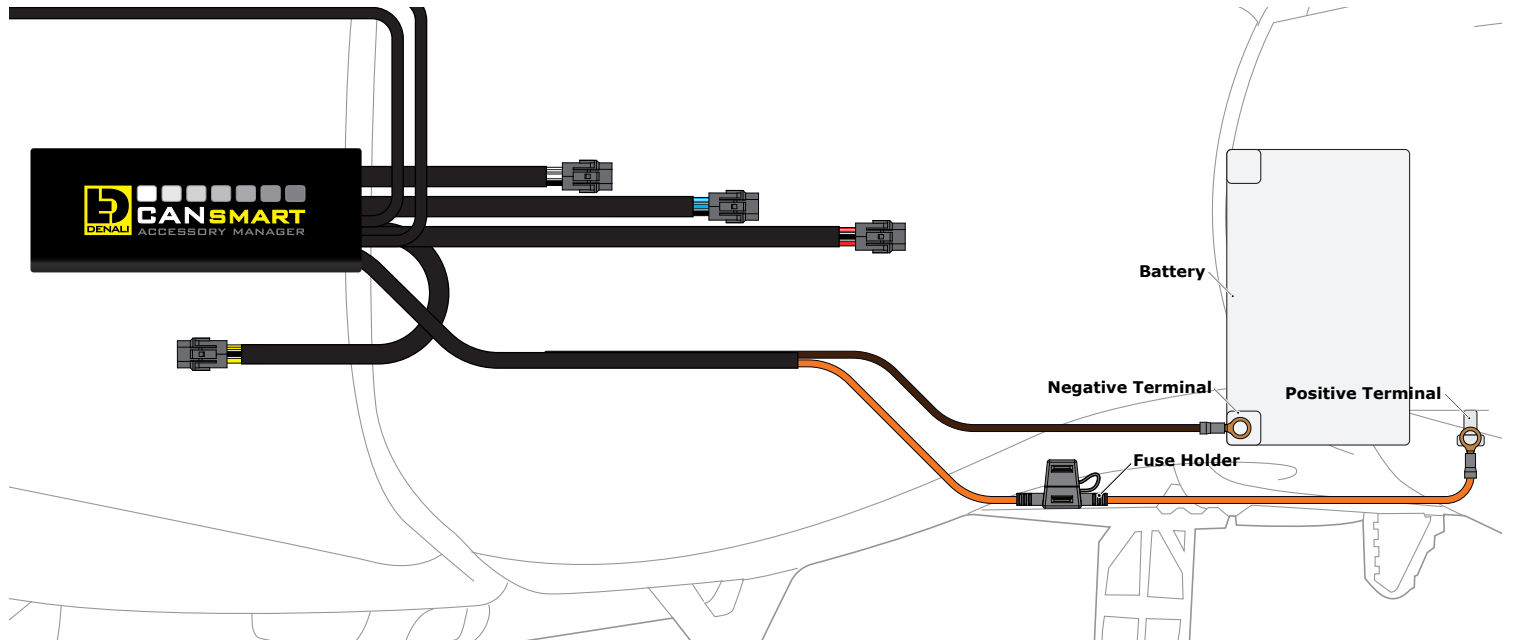

## 4.1 - Connect To The Battery

- Step One:** Remove the fuse from the fuse holder.
  - Step Two:** Gain access to the vehicle's battery and disconnect the negative (-) and positive (+) terminals.
  - Step Three:** Connect the CANsmart™ wiring harness to the battery via the ring terminals. Be sure the orange wire lead with the fuse holder goes to the positive (+) terminal of the battery.
  - Step Four:** Re-install the fuse into the fuse holder.
- Note:** Place the fuse holder in an easily accessible location for convenient service in the event of a blown fuse.

# 5. Alternate Light Wiring Options

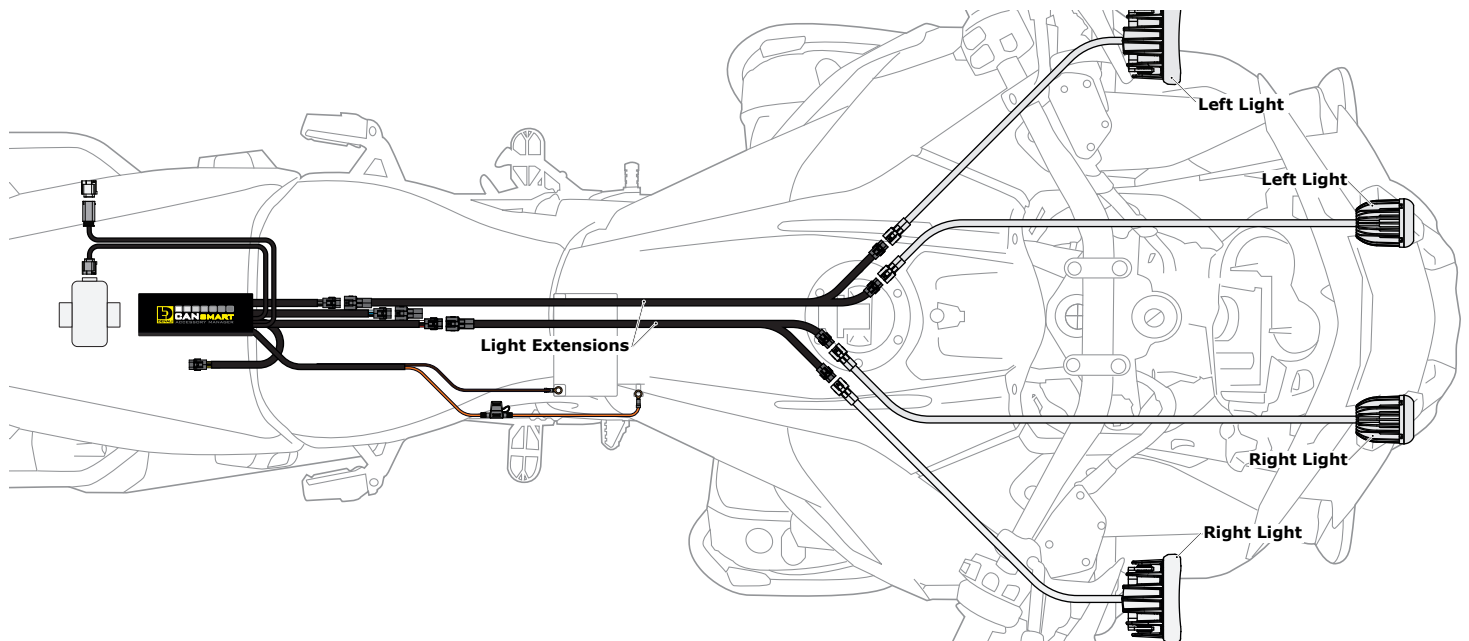

## 5.1 - Left/Right Split Lights

Wiring your LED Lights split left/right enables the "Off When Turn Signal Active" feature to cancel only the LED lights on the corresponding side of the bike that the signal was activated. When lights are wired as sets (Figure 3.1), the LED lights on both sides of the bike will cancel regardless which side turn signal is activated.

**One:** Plug the male 3-pin connector of the Light Extension-Splitter into one of the CANsmart™ Controller's light circuits.

**Step Two:** Begin routing the harness toward the front of the bike. Secure the harness to the vehicle's frame along the way with the included zip ties. Be sure to avoid any moving components such as radiator fan blades or

**Step Three:** Plug the DENALI Light Pods from the right side of the motorcycle into the female 3-pin connectors of the Extension-Splitter. Repeat steps One through Three using a second Light Extension-Splitter for the lights on the left side of the motorcycle

**Step Four:** Connect the CANsmart to the Device Manager Software. Using Circuit Function Selector, reassign the circuits used to be "Left Light 1" for the circuit powering the left side LED lights, and "Right Light 1" for the circuit powering the right side LED lights.

## 6.1 - Circuit Function Selector

The Circuit Function Selector in the CANsmart software will let you run any accessory of your choice on any of the four circuits. Click on a circuit icon to open the drop down menu and make your selection from the list of available circuit functions. Continue reading for an overview of each circuit function and its available settings.

## 6.2 - Auxiliary Lights One (Pair or Split)

The Auxiliary Light One circuit function enables independent adjustment of high and low beam brightness right from the vehicle's "Trip" switch. Available settings include "Off when turn signal active", "Strobe when horn active", "Strobe on flash to pass", "Inverse flashing when hazards active" as well as "Modulation". "Three-Wire dimming mode" can be turned off to properly dim LED lights which do not have a dedicated 3rd dimming wire. From the extra settings window you can adjust the "Strobe Intensity" as well as the "Modulation variation".



# 6. Circuit Functions & Settings (continued) DENALIELECTRONICS.COM

Auxiliary Lights **Two**

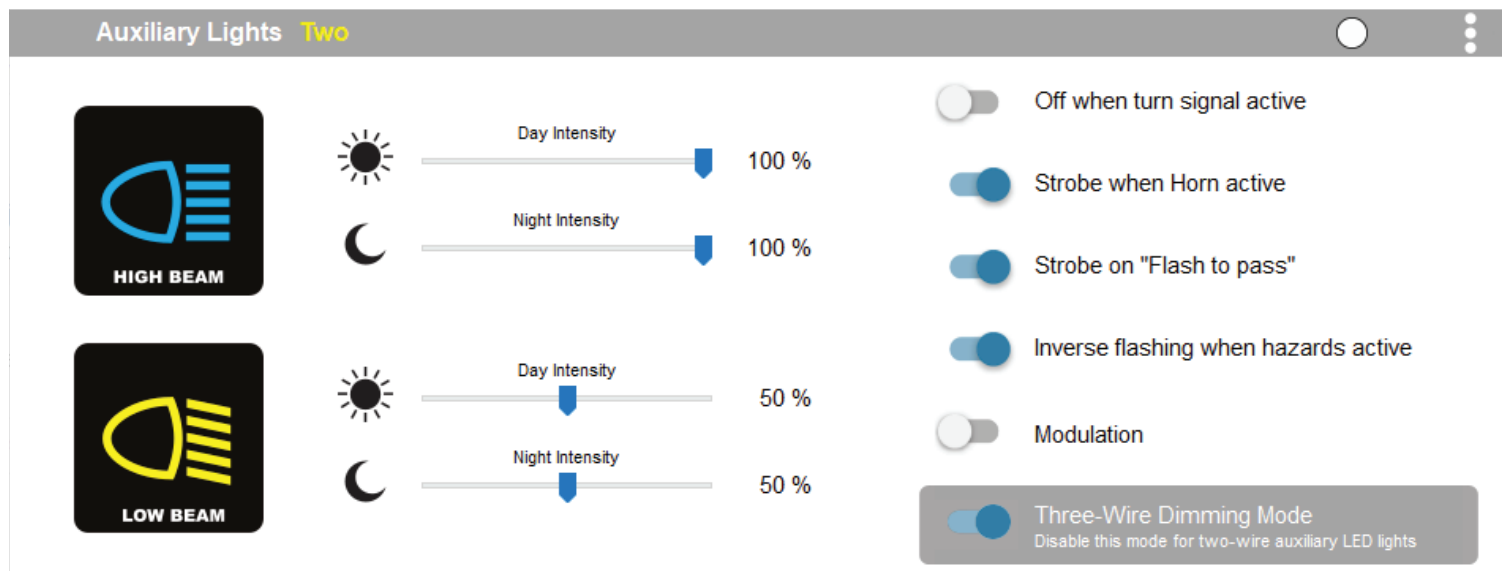

The interface for Auxiliary Lights Two features two main sections: High Beam and Low Beam. Each section includes a sun icon for Day Intensity and a moon icon for Night Intensity, with sliders set to 100% for High Beam and 50% for Low Beam. To the right, there are five toggle switches: 'Off when turn signal active' (off), 'Strobe when Horn active' (on), 'Strobe on "Flash to pass"' (on), 'Inverse flashing when hazards active' (on), and 'Modulation' (off). A 'Three-Wire Dimming Mode' toggle is also present, currently turned on, with a note to 'Disable this mode for two-wire auxiliary LED lights'.

## 6.3 - Auxiliary Lights Two (Pair or Split)

The Auxiliary Light Two circuit function enables independent adjustment of high and low beam brightness right from the vehicle's "Trip" switch. Available settings include "Off when turn signal active", "Strobe when horn active", "Strobe on flash to pass", "Inverse flashing when hazards active" as well as "Modulation". "Three-Wire dimming mode" can be turned off to properly dim LED dimming lights which do not have a dedicated 3rd dimming wire. From the extra settings window you can adjust the "Strobe Intensity" as well as the "Modulation variation".

Auxiliary Brake Light

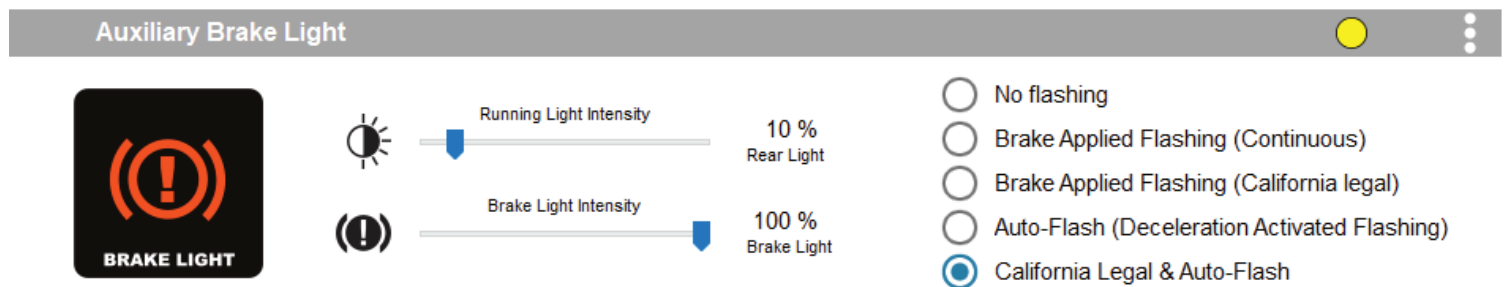

The Auxiliary Brake Light settings interface includes a 'BRAKE LIGHT' icon and two intensity sliders: 'Running Light Intensity' set to 10% for the Rear Light, and 'Brake Light Intensity' set to 100% for the Brake Light. On the right, there are five radio button options for flashing patterns: 'No flashing', 'Brake Applied Flashing (Continuous)', 'Brake Applied Flashing (California legal)', 'Auto-Flash (Deceleration Activated Flashing)', and 'California Legal & Auto-Flash' (which is selected).

## 6.4 - Auxiliary Brake Light

The feature-rich Auxiliary Brake Light circuit function will transform a simple 2-wire brake light into a "smart brake light" complete with running light, multiple flash patterns, and deceleration activated braking functionality. From the extra settings window you can also adjust the "Brake Flashing Travel Speed" as well as the "Deceleration activated braking sensitivity".

Auxiliary Horn



The Auxiliary Horn settings interface features a 'HORN' icon and a single toggle switch labeled 'Horn enabled', which is currently turned on.

## 6.5 - Auxiliary Horn

The horn circuit enables the addition of an auxiliary horn without having to add a relay and dedicated horn wiring harness.

Accessory / Ignition Supply

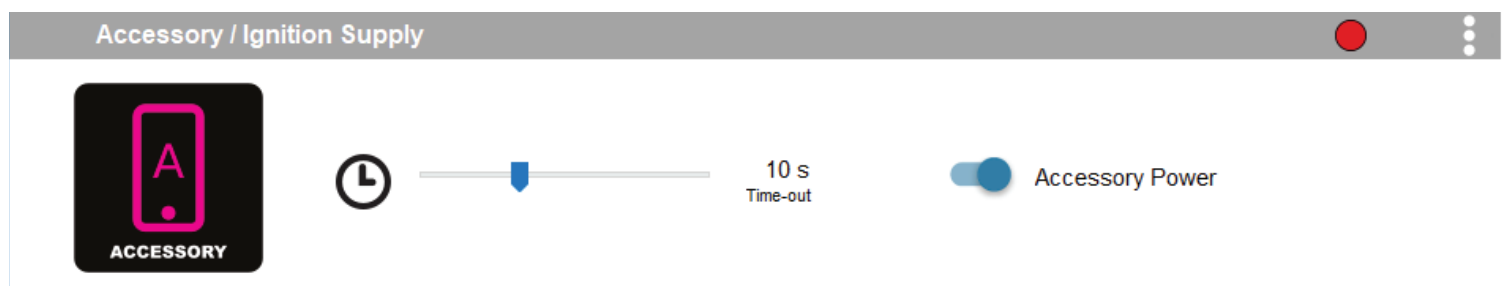

The Accessory / Ignition Supply settings interface includes an 'ACCESSORY' icon, a clock icon, a slider set to 10s Time-out, and a toggle switch labeled 'Accessory Power', which is currently turned on.

## 6.6 - Accessory

The Accessory circuit function will provide simple switched 12v power to an accessory of your choice when the motorcycles ignition is turned on.

## Controlling Accessories From The Motorcycle

Auxiliary Light Set One (Red/Yellow Circuit)	
On/Off	Press and hold turn signal cancel button for 3 seconds.
Enter WonderWheel Dimming Mode	Hold "WonderWheel" left for 3 seconds.
Adjust Intensity	Scroll "WonderWheel" up/down to adjust between 0% to 100%.
Exit WonderWheel Dimming Mode	Hold "WonderWheel" left for 1 second or wait for 5 second time out.
Auxiliary Light Set Two (Red/Yellow Circuit)	
On/Off	Rapidly press turn signal cancel button 3 times.
Enter WonderWheel Dimming Mode	Hold "WonderWheel" right for 3 seconds.
Adjust Intensity	Scroll "WonderWheel" up/down to adjust between 0% to 100%.
Exit WonderWheel Dimming Mode	Hold "WonderWheel" right for 1 second or wait for 5 second time out.
Auxiliary Horn (Green Circuit)	
Sound Auxiliary Horn	Press vehicle's original horn button.
Auxiliary Brake Light (Orange Circuit)	
Activate Auxiliary Brake Light	Apply vehicle's front or rear brakes. (Can be set to flash upon deceleration.)

### 7.1 - Where To Download The Software

The CANsmart™ Accessory Manager Software is available for both Windows and Mac operating systems. To download your copy please visit [WWW.DENALIELECTRONICS.COM/cansmart-user-guide](http://WWW.DENALIELECTRONICS.COM/cansmart-user-guide)

### 7.2 - Connecting The Device To The Software

**Step One:** Remove the protective cap from micro USB port on the end of the CANsmart™ Controller.

**Step Two:** Plug the provided programming cable into the CANsmart™ Controller, and plug the other end into your computers USB port.

**Step Three:** Open the CANsmart Accessory Manger Software and turn the motorcycle's ignition to the "ON" position.

## 8. Troubleshooting Guide

### CANsmart™ Status Indicator Light Key

LED Color	Status	Solution
Solid Green	Normal operation, no errors present. (Vehicle Ignition ON)	N/A
Slow Flashing Green	Normal operation, no errors present. (Vehicle Ignition OFF)	N/A
Quick Flashing Green	Bootloader Mode (Should only be seen during firmware upgrade)	Connect to software, should reset into normal operation
Solid Red	Recovered from an unexpected failure	Connect to software, should attempt to reset to normal operation. Please report the exact circumstances to DENALI for analysis.
Flashing Red	At least one channels electronics fuse has been tripped.	Check/increase fuse settings, cycle ignition to reset electronic fuses
Solid Green & Flashing Red	Application Firmware Corrupt	Connect to software, should offer an upgrade/recovery
Solid Red & Solid Green	Device has been deactivated	Return to DENALI for analysis. Please send log files <a href="mailto:info@DENALIElectronic.com">info@DENALIElectronic.com</a> for analysis by DENALI.
Flashing Red & Flashing Green	Data/configuration fault. (missing CAN bus data)	Check that the correct CAN bus connector was used. If the problem persists please send log files to <a href="mailto:info@DENALIElectronics.com">info@DENALIElectronics.com</a> for analysis by DENALI

### 8.1 - Status Indicator Light

The CANsmart controller features a LED status indicator light, the light is located next to the micro USB programming port. The chart above defines each of the LED colors/flash patterns, and provides possible solutions to any faults that are present in the system.

The screenshot shows a 'Diagnostics' window with the following data:

- Current measurements:**
  - Red Circuit: Average: 0.00 A, Peak: 0.00 A
  - Blue Circuit: Average: 0.00 A, Peak: 0.00 A
  - Yellow Circuit: Average: 0.00 A, Peak: 0.00 A
  - White Circuit: Average: 0.00 A, Peak: 0.00 A
- Temperature measurement:** Temperature: 27.50
- Voltage measurement:**
  - Battery Voltage: 0.00 V
  - CANBUS Voltage: 0.00 V

### 8.2 - Diagnostics Windows

The Diagnostics Window can be opened from the main menu. Use this window to get an overall view of the systems power consumption, as well as Battery/CAN bus voltage and device temperature.

### 8.3 - Online Trouble Shooting Guide

For the most up to date comprehensive trouble shooting guide, please visit [DENALIElectronics.com/cansmart-user-guide](http://DENALIElectronics.com/cansmart-user-guide)