



INSTALLATION

SADDLEBAG LIDS WITH SPEAKERS/GRILLS 873,878,892,893

PARTS INCLUDED

- 1 Left Saddlebag Lid with Kicker 6 X 9 Speaker and Tweeter—Chrome Grill
- 1 Right Saddlebag Lid with Kicker 6 X 9 Speaker and Tweeter—Chrome Grill
- 2 60" Rubber Seal
- 2 Series Speaker Harnesses
- 2 Parallel Speaker Harnesses
- 2 Cord Keepers
- 2 Rubber Grommets
- 2 6" Nylon Cable Ties
- 10 #6-32 X 3/8" Button Socket Cap Screws
- 10 #6 Flat Washers
- 2 Scuff Pads
- 1 Damper Pad Set
- 2 Damper Strips
- 1 Installation Instructions

Please read and understand entire instructions before starting installation.

THANK YOU FOR CHOOSING KÜRYAKYN!

IN ORDER TO PROTECT YOU AND OTHERS FROM POSSIBLE INJURY AND/OR PROPERTY DAMAGE OR LOSS, PLEASE PAY CLOSE ATTENTION TO ALL INSTRUCTIONS, WARNINGS, CAUTIONS AND ATTENTION NOTES REGARDING THE USE AND CARE OF THIS PRODUCT.

ATTENTION! This indication alerts you to the fact that ignoring the contents described herein may negatively affect product performance and functionality.

CAUTION! This indication alerts you to the fact that ignoring the contents described herein can result in potential injury or material damage.

TOOLS SUGGESTED

Set of Torx Wrenches, Drill and Drill Bits, Center Punch, Non-permanent Marker

STEP 1 Read and understand all steps in the instructions before starting the installation. Park the motorcycle on a hard, level surface and turn off the ignition.

ATTENTION! If you are not using a Kuryakyn amplifier, P/N 871, with these speakers, you will have to fabricate your own wiring harness to connect the speakers to the motorcycle sound system.

ATTENTION! These Saddlebag Lids with Speakers were designed to work with Kuryakyn P/N 871, Kicker Amp. Installation of these without the Kicker Amp will not produce the desired sound quality. Kuryakyn WILL NOT warranty these Saddlebag Lids with Speakers for sound quality if installed without an amp.

ATTENTION! A factory service manual may be helpful in performing this installation. Do not attempt to perform this installation if you are not confident in your ability to complete all of the steps in the procedure; consult a trained technician.

STEP 2 Remove the saddlebags from the motorcycle.

CUSTOMER SERVICE

877.370.3604 (toll free)

INSTALLATION QUESTIONS

techsupport@kuryakyn.com
or call 715.247.2983

LIMITED WARRANTY

Kuryakyn warrants that any Kuryakyn products sold hereunder, shall be free of defects in materials and workmanship for a period of one (1) year from the date of purchase by the consumer excepting the following provisions:

- Kuryakyn shall have no obligation in the event the customer is unable to provide a receipt showing the date the customer purchased the product(s).
 - The product must be properly installed, maintained and operated under normal conditions.
 - Kuryakyn makes no warranty, expressed or implied, with respect to any gold plated products.
 - Kuryakyn shall not be liable for any consequential and incidental damages, including labor and paint, resulting from failure of a Kuryakyn product, failure to deliver, delay in delivery, delivery in nonconforming condition, or for any breach of contract or duty between Kuryakyn and a customer.
- Kuryakyn products are often intended for use in specific applications. Kuryakyn makes no warranty if a Kuryakyn product is used in applications other than intended.
- Kuryakyn electrical products are warranted for one (1) year from the date of purchase by the consumer. L.E.D.'S contained in components of Kuryakyn products will be warranted for defects in materials and workmanship for 3 years from the date of purchase where as all other components shall be warranted for one(1) year. This includes, but is not limited to; control modules, wiring, chrome & other components.

• Kuryakyn makes no warranty of any kind in regard to other manufacturer's products distributed by Kuryakyn. Kuryakyn will pass on all warranties made by the manufacturer and where possible, will expedite the claim on behalf of the customer, but ultimately, responsibility for disposition of the warranty claim lies with the manufacturer.

ABOUT OUR CATALOG

For purchasing Kuryakyn® products, you can receive a complete catalog free of charge. Send the Proof-of-Purchase below with your address to: Kuryakyn, P.O. Box 339, Somerset, WI 54025. Please indicate either Accessories Catalog for Harley-Davidson® or GL & Metric Cruisers.

Be sure to ask your local dealer about other Kuryakyn® products, the motorcycle parts and accessories designed for riders by riders.

©2005 Kuryakyn USA® All Rights reserved.



kuryakyn.com

CAUTION! Avoid damage to the motorcycle. Protect painted surfaces with a soft cloth or blanket.

STEP 3 Open the right saddlebag lid, and remove the two Torx head screws that secure the tether strap to the saddlebag shown in PIC 1. Set these screws aside, they will be re-used.

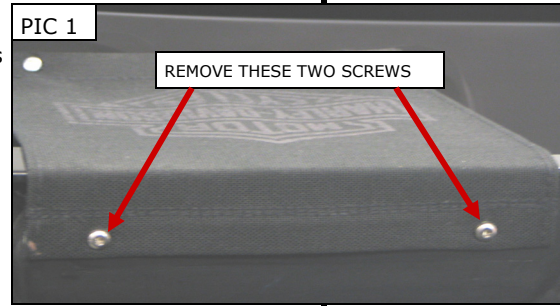

ATTENTION! Assistance recommended in holding the saddlebag lid after all of the Torx screws have been removed to prevent damage.

STEP 4 Remove the five Torx screws securing the lid to the latch. Remove the retaining plate from between the foam weather stripping and the saddlebag lid PIC 2. Set the retaining plate aside, it will be reused.

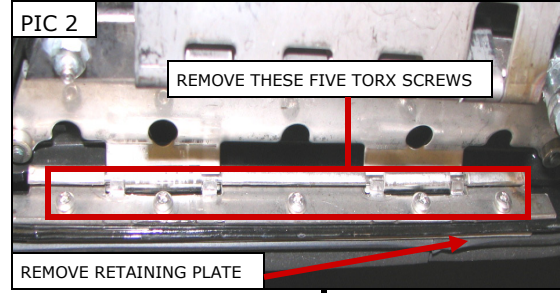

STEP 5 Set the right side lid on the right side saddlebag. Using the hinge as a guide, carefully mark the ends of the hinge on the saddlebag lid. PIC 3

STEP 6 Using the retaining plate from Step 4 as a guide, line the edge of the plate up with the bottom edge of the new Saddlebag lid with the end of the hinge marks made in Step 5 PIC 4. Mark the location of all five holes on the lid.

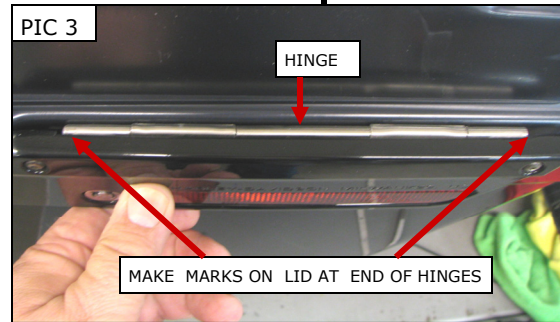

CAUTION! **MEASURE TWICE – DRILL ONCE.** Double check all reference marks made on the saddlebag lids **BEFORE** drilling. Kuryakyn will not be responsible for incidental or consequential damages resulting from this installation.

STEP 7 Using a center punch, mark the center of the five holes. (Remove the lid from the saddlebag before drilling.) Using an 1/8" drill bit, drill the five mounting holes in the lid. PIC 5

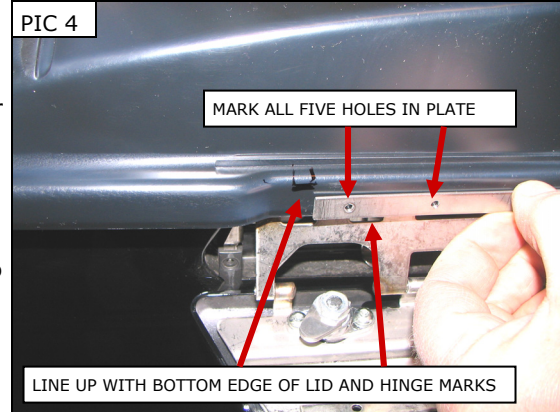

CAUTION! Avoid damage to the motorcycle. Protect painted surfaces with a soft cloth or blanket.

STEP 8 Place a #6 Flat Washer on 5 of the included #6-32 X 3/8" Button Socket Cap Screws, and using the retaining plate from Step 6, attach the new lid to the saddlebag.

STEP 9 Set the saddlebag with the Speaker Lid open on a soft cloth on a bench or the floor. Clean the inside ledge of the saddlebag lid with an ammonia based cleaner such as window cleaner. Let dry. Starting in the middle of the back side of the lid, PIC 6, attach the foam weather stripping to the ledge of the lid.



STEP 10 Using the Torx screws removed in Step 3, attach the ends of the cables to the saddlebag. PIC 7

ATTENTION! It is the end user's responsibility to ensure that all of the fasteners (including pre-assembled) are tightened before operation of the motorcycle. Kuryakyn will not issue a warranty on components lost due to improper installation. Periodic maintenance may be required.

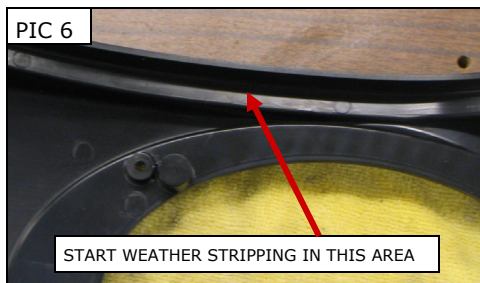

-cont.-

CAUTION! **MEASURE TWICE – DRILL ONCE.** Double check all reference marks made on the saddlebag **BEFORE** drilling. Kuryakyn will not be responsible for incidental or consequential damages resulting from this installation.

STEP 11 Drill a 3/8" hole in the back side of the Saddlebag near the front fastener. Thread the Speaker Lid wires through the hole. Slit the supplied rubber grommet and place it around the wires and secure it in the hole in the side of the saddlebag. PIC 9 Reinstall the saddlebag.

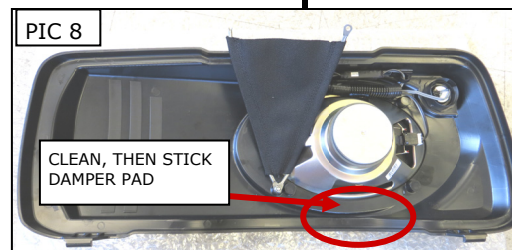

STEP 12 Route the wires from the speaker around the front inside edge of the saddlebag and secure with one of the included cord keepers.

STEP 13 Clean the inside of the lid and the top of the shock indent of the saddlebag with an ammonia based cleaner such as window cleaner. PIC 8 and 10

STEP 14 Peel the backing off of one of the supplied Damper Strips and Pads. Line up the long edge of the Strip with the inside edge of the saddlebag and adhere it to the top of the shock indent. Stick the Pad to the inside of the Lid. PIC 8 and 11

NOTE: Damper Strip and Pad **MUST** be installed to prevent wear to the top of the shock indent.

STEP 15 Repeat Step 3 through Step 14 for the left saddlebag.

CAUTION! It is up to the installer to determine if installing Saddlebag Lids with Speakers, P/N 873, without Kuryakyn P/N 871, Kicker Amp, could damage the sound system on the motorcycle. Kuryakyn will not be responsible for incidental or consequential damages to the sound system resulting from improper wiring of the Saddlebag Lids with Speakers to the existing sound system.

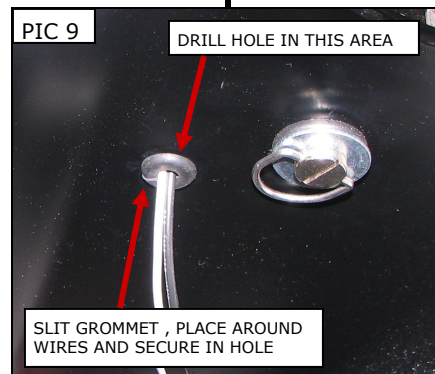

STEP 16 These speakers are designed to work with Kuryakyn /Kicker Amp, P/N 871. If you are not using this Amp, you will need to fabricate your own wiring harness to connect these speakers to your system.

WIRING FOR TWO OEM/KICKER FRONT SPEAKERS WITH KURYAKYN AMP, P/N 871, ADDING KURYAKYN SADDLEBAG LIDS WITH SPEAKERS

NOTE: The following installation steps require Y connectors that were provided with the Kuryakyn Amp P/N 871.

ATTENTION! Kuryakyn recommends the use of dielectric grease on electrical connections.

STEP 17 Remove the outer fairing per steps in the service manual. Remove the seat.

STEP 18 Refer to Figure 1 on Page 7. Locate and connect the Rear Extension Harness to the same colored wires from the Amp.

STEP 19 Remove the wiring sections that are labeled "TO REAR OEM SPEAKER WIRES" from the Rear Extension Harness. Route the GREEN set of wires towards the Left front OEM/Kicker speaker. Route the PURPLE set towards the Right front OEM/Kicker speaker.

STEP 20 Leaving a little slack in each (GREEN and PURPLE) set of wires, cut them to length to reach the OEM/Kicker speakers on each side. GREEN to the Left, PURPLE to the Right. **NOTE: The following uses connectors provided with the Kuryakyn Amp, P/N 871.** Strip the insulation back about 3/8" and install one of the Large Female Spade connectors to the PURPLE/BLACK stripe wire and one to the GREEN/BLACK stripe wire. Strip the insulation back about 3/8" and install one of the Small Female Spade connectors to the PURPLE and to the GREEN wires. PIC 2 on Page 6

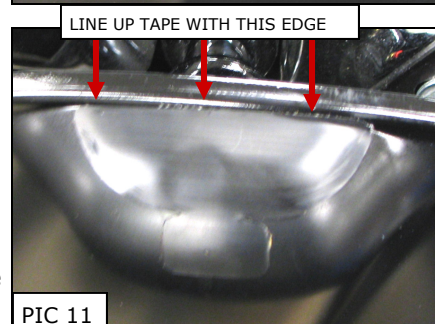
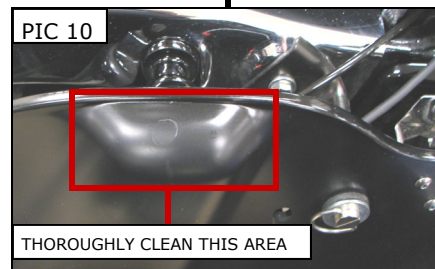

-cont.-

STEP 21 Connect the male spade on end of the GRAY wire labeled "FRONT OEM SPEAKER WIRES" to the female spade on the White Y connector on the Right speaker power wire from the bike. Connect the female spade installed in Step 20 on the Purple wire to the second male spade on the White Y connector.

NOTE: Using electrical tape over each of the Male To Female Spade connections in the following steps will ensure the connections stay together and help prevent any electrical interference.

STEP 22 Connect the male spade on the end of the GRAY/BLACK wire to the female spade on the Black Y connector on the Right speaker negative wire from the bike. Connect the female spade installed in Step 21 on the Purple/Black to the second male spade on the Black Y connector. Repeat for the Left side (GREEN and WHITE). PIC 1 and 2 on Page 6

STEP 23 Route the remaining sections of the Rear Extension harness over the lower triple tree and under the tank to the seat area. Use the included cable ties to secure these away from pinch points and the motor. You may want to raise or remove the fuel tank to route these.

ATTENTION! Secure all wiring away from any moving parts, pinch points or extreme heat. Kuryakyn WILL NOT issue a warranty on any electrical component that fails due to pinched, crimped, broken, abraded, melted or frayed wires.

STEP 24 **NOTE:** The following uses Single Speaker Harnesses provided with the Kuryakyn Amp, P/N 871. Connect one of the single speaker harnesses to each of the GREEN and PURPLE harnesses labeled "TO REAR SPEAKER HARNESS". Connect the single speaker harness on the GREEN harness to the left rear speaker and the single speaker harness on the PURPLE harness to the right rear speaker.

STEP 25 Test the system for proper operation. Reinstall the seat and outer fairing.

WIRING FOR OEM/KICKER REAR SPEAKERS WITH KURYAKYN AMP, P/N 871, ADDING SADDLEBAG LIDS WITH SPEAKERS

STEP 26 Remove the seat.

ATTENTION! Kuryakyn recommends the use of dielectric grease on electrical connections.

STEP 27 Remove the Single Speaker Harness from the GREEN and PURPLE harnesses labeled "TO REAR SPEAKER HARNESS". Connect one of the included Series or Parallel harnesses to these GREEN and PURPLE harnesses.

NOTE: Use the examples on Page 5 to determine whether to use the SERIES or PARALLEL harness in the following STEPS.

STEP 28 Remove the rear speakers from the housings on the Tour-Pak. Route one set of the Series (on the PURPLE wires) harness or one set of wires on the Parallel harness, to the inside of the housing where the single speaker harness was removed from and connect to the speaker on the right side. Connect small Male spade on the speaker to small Female spade on the harness, large to large.

STEP 29 Connect one set of the Series Harness (on the PURPLE wires) or one set from the Parallel harness, to the Saddlebag Lid Speakers. Connect small Male spade to small Female spade, large to large.

STEP 30 Reinstall the right rear speaker to the housing on the bike. Secure the wiring out of harms way.

STEP 31 Repeat for the left (GREEN harness) side.

STEP 32 Test the system for proper operation. Reinstall the seat.

ATTENTION! Secure all wiring away from any moving parts, pinch points or extreme heat. Kuryakyn WILL NOT issue a warranty on any electrical component that fails due to pinched, crimped, broken, abraded, melted or frayed wires.

-cont.-

WIRING HARNESS COLOR KEY CHART
LEFT AND RIGHT ARE AS SITTING ON THE BIKE

- WHITE**— LEFT FRONT POSITIVE **WHITE/BLACK STRIPE**— LEFT FRONT NEGATIVE
- GRAY**— RIGHT FRONT POSITIVE **GRAY/BLACK STRIPE**— RIGHT FRONT NEGATIVE
- GREEN**— LEFT REAR POSITIVE **GREEN/BLACK STRIPE**—LEFT REAR NEGATIVE
- PURPLE**— RIGHT REAR POSITIVE **PURPLE/BLACK STRIPE**— RIGHT REAR NEGATIVE

THE LONG HARNESSSES WITH THE **GREEN** AND THE **GREEN/BLACK** WIRES NEED TO BE ROUTED TO THE LEFT REAR OF THE BIKE IF THE BIKE HAS EXISTING REAR SPEAKERS

THE LONG HARNESSSES WITH THE **PURPLE** AND **PURPLE/BLACK** WIRES NEED TO BE ROUTED TO THE RIGHT REAR OF THE BIKE IF THE BIKE HAS EXISTING REAR SPEAKERS

THE MID LENGTH HARNESS WITH THE HEAVY **RED** WIRE WITH THE FUSE HOLDER IS THE POSITIVE TO THE BATTERY AND THE HEAVY **BLACK** WIRE IS NEGATIVE TO THE BATTERY

THE **BLUE** WIRES FROM THE AMP ARE AN EXTENSION FOR THE SUBWOOFER AND **WILL NOT BE USED AT THIS TIME.**

THE **POSITIVE** SIDE OF THE SPEAKER HAS THE **SMALL** SPADE CONNECTOR

THE **NEGATIVE** SIDE OF THE SPEAKER HAS THE **LARGE** SPADE CONNECTOR

THE **WHITE "Y"** ADAPTER IS FOR THE **POSITIVE** SIDE OF THE SPEAKER WIRING

THE **BLACK "Y"** ADAPTER IS FOR THE **NEGATIVE** SIDE OF THE SPEAKER WIRING

CAUTION!

It is up to the installer to ensure that the total speaker Ohms on each channel is within the operating range of the Kicker Amp. This range is 2 Ohms minimum to 8 Ohms maximum. Check your speakers to find the Ohms listed. **KURYAKYN WILL NOT** warranty speakers or Amps that have failed due to incorrect wiring.

PARALLELL WIRING

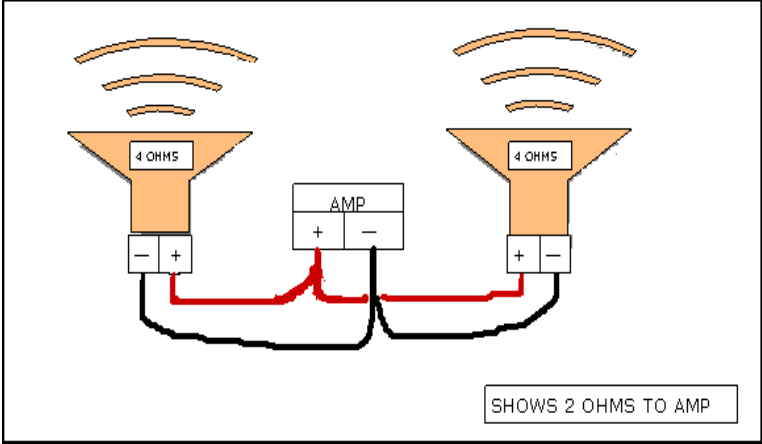

SERIES WIRING

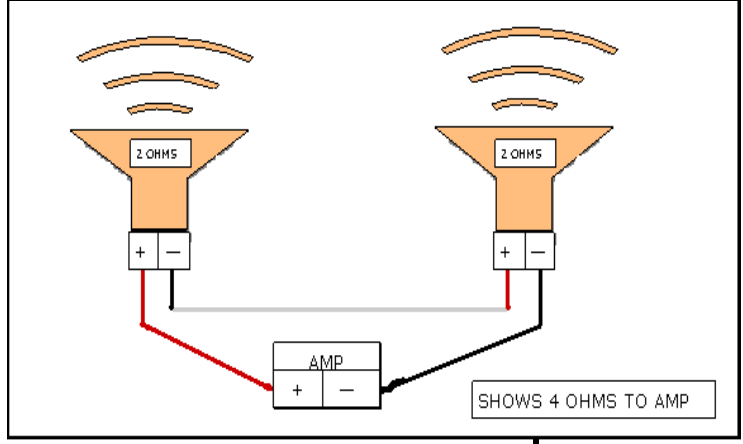

This diagram divides the bike into four zones or sections that are called Channels. Each channel includes all speakers in that zone or section. To determine the correct OHMS for each channel, use the Ohms of each speaker in the zone or section and the formulas given for Series wiring or Parallel wiring.

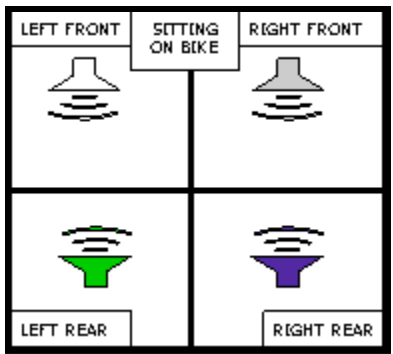

SERIES

When speakers are added and wired in series' add the Ohms from each speaker on that channel together to get the total Ohms.
Example: 4 Ohms + 2 Ohms = 6 Ohms which is in the range of acceptable Ohms.

PARALLEL

When speakers are wired in parallel to get the total Ohms, multiply the Ohms from each speaker on a channel together. Divide that by the amount from adding the Ohms of each speaker on that channel together.
Example: 4 Ohms X 2 Ohms / 4 Ohms + 2 Ohms = 1.3 Ohms which would be too low.

-cont.-

WIRING SADDLEBAG LID SPEAKERS ON BIKES WITH NO EXISTING REAR SPEAKERS

PIC 1

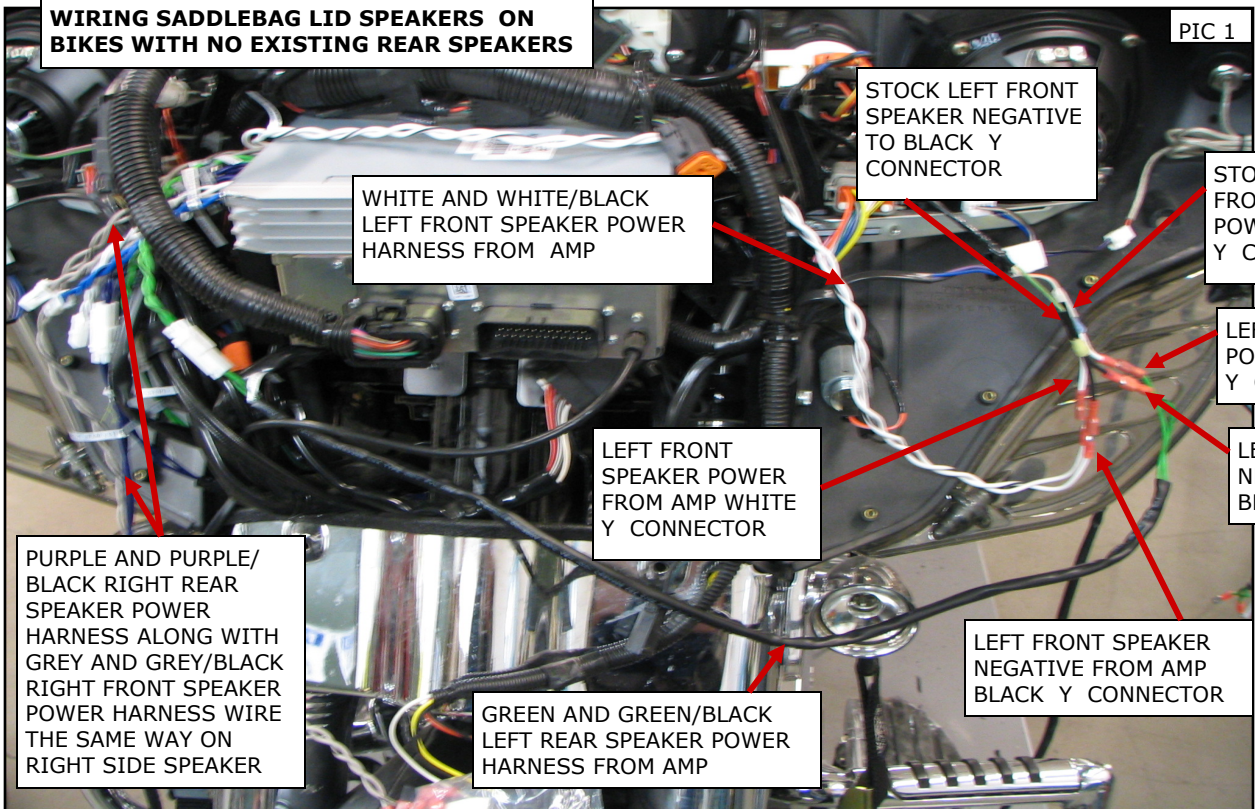

STOCK LEFT FRONT SPEAKER NEGATIVE TO BLACK Y CONNECTOR

WHITE AND WHITE/BLACK LEFT FRONT SPEAKER POWER HARNESS FROM AMP

STOCK LEFT FRONT SPEAKER POWER TO WHITE Y CONNECTOR

LEFT REAR SPEAKER POWER FROM AMP WHITE Y CONNECTOR

LEFT FRONT SPEAKER POWER FROM AMP WHITE Y CONNECTOR

LEFT REAR SPEAKER NEGATIVE FROM AMP BLACK Y CONNECTOR

PURPLE AND PURPLE/BLACK RIGHT REAR SPEAKER POWER HARNESS ALONG WITH GREY AND GREY/BLACK RIGHT FRONT SPEAKER POWER HARNESS WIRE THE SAME WAY ON RIGHT SIDE SPEAKER

GREEN AND GREEN/BLACK LEFT REAR SPEAKER POWER HARNESS FROM AMP

LEFT FRONT SPEAKER NEGATIVE FROM AMP BLACK Y CONNECTOR

PIC 2

WIRING SADDLEBAG LID SPEAKERS ON BIKES WITH NO EXISTING REAR SPEAKERS CLOSE-UP OF Y CONNECTORS LEFT SIDE OF BIKE

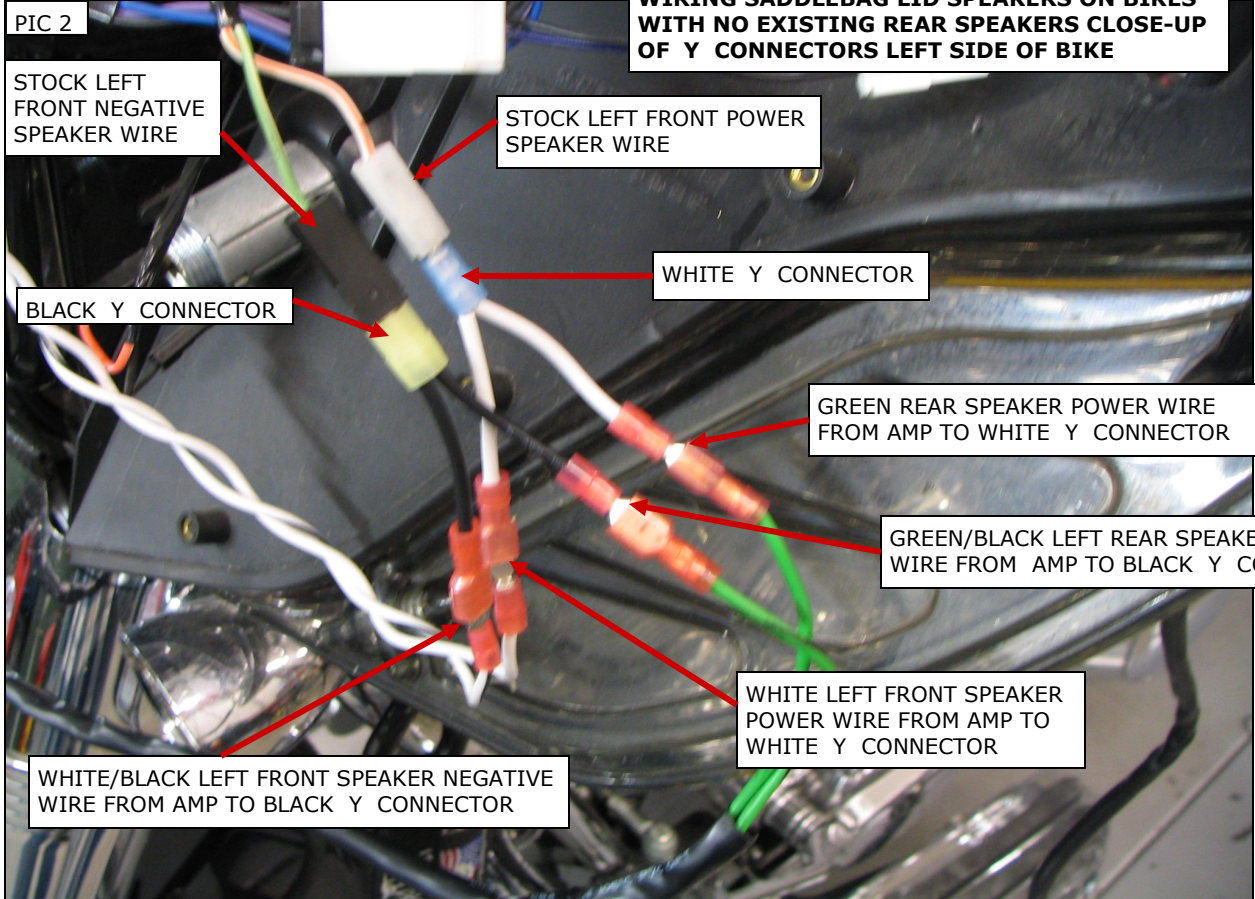

STOCK LEFT FRONT NEGATIVE SPEAKER WIRE

STOCK LEFT FRONT POWER SPEAKER WIRE

WHITE Y CONNECTOR

BLACK Y CONNECTOR

GREEN REAR SPEAKER POWER WIRE FROM AMP TO WHITE Y CONNECTOR

GREEN/BLACK LEFT REAR SPEAKER NEGATIVE WIRE FROM AMP TO BLACK Y CONNECTOR

WHITE LEFT FRONT SPEAKER POWER WIRE FROM AMP TO WHITE Y CONNECTOR

WHITE/BLACK LEFT FRONT SPEAKER NEGATIVE WIRE FROM AMP TO BLACK Y CONNECTOR

-cont.-

FIG 1
USE THESE HARNESSES AND Y
CONNECTORS FOR TWO OEM/
KICKER FRONT SPEAKERS AND
KURYAKYN SADDLEBAG LID
SPEAKERS —MODIFIED EXTENSION
HARNESS SHOWN

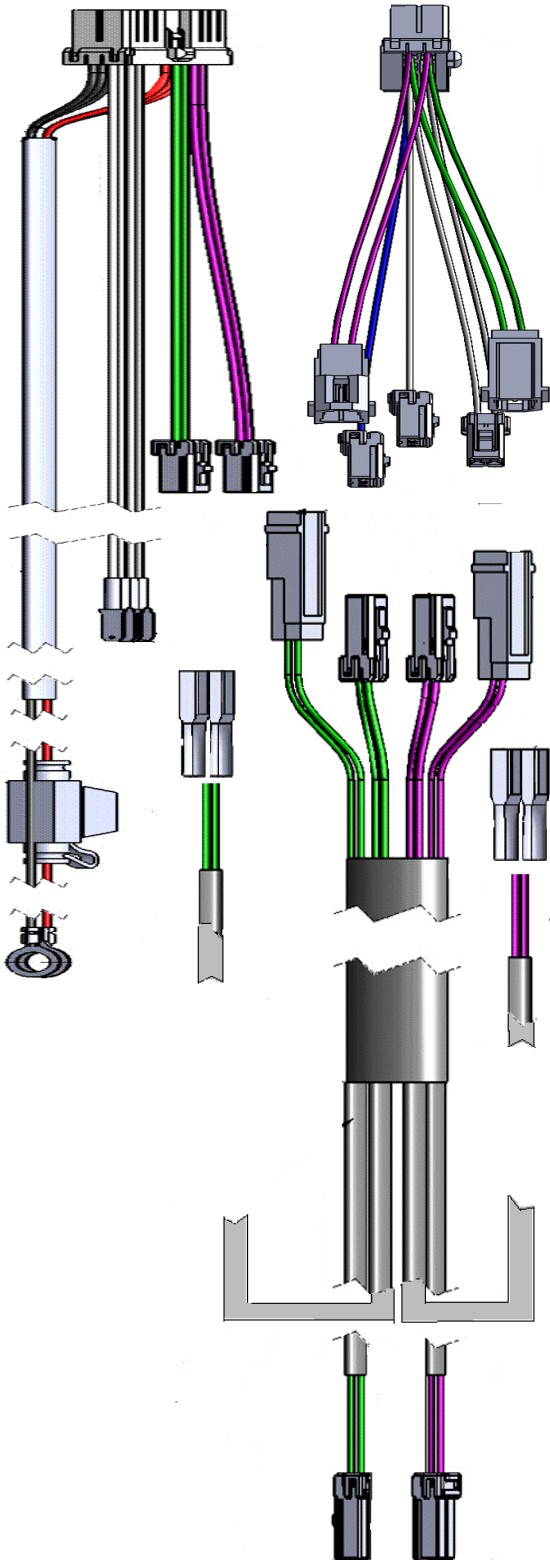
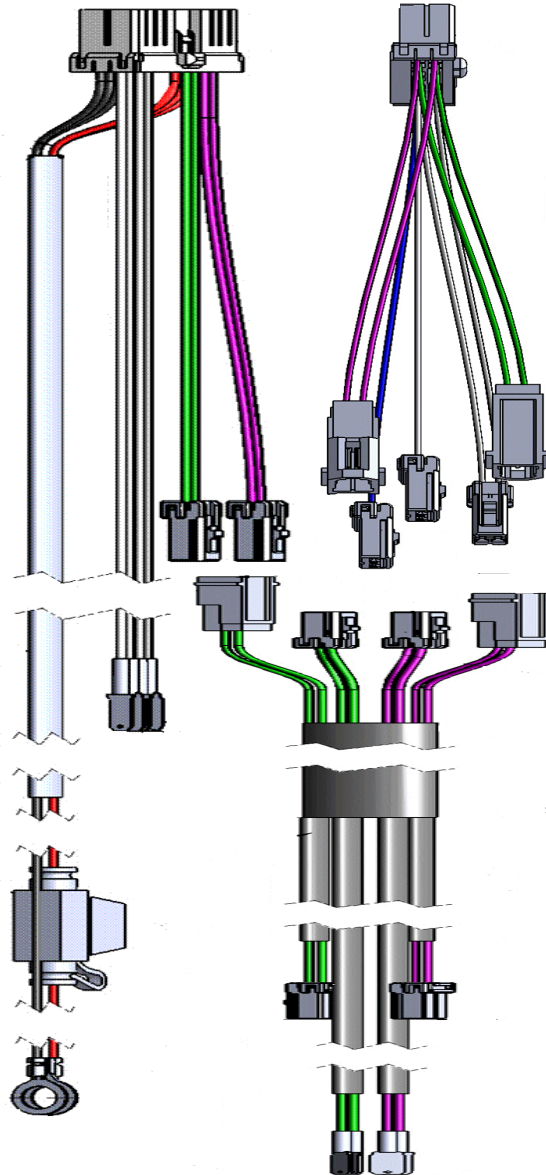
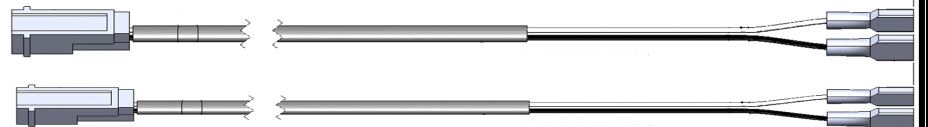
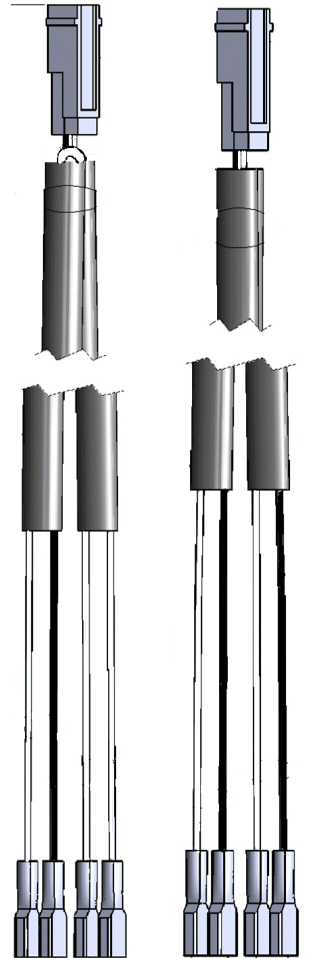

FIG 2
USE THESE HARNESSES FOR FOUR
OEM/KICKER SPEAKERS—
SADDLEBAG LID SPEAKERS



USE TWO PARALLEL OR
 SERIES EXTENSIONS
 DEPENDING ON
 SPEAKER OHMS

SERIES	PARALLEL
--------	----------



USE THESE HARNESSES
 AND Y CONNECTORS
 FROM THE 871 KIT FOR
 STREET GLIDES, ROAD
 GLIDES AND ELECTRA
 GLIDE CLASSICS

