



CHASSIS PROTECTOR KIT

APPLICATION

YEAR	MODEL
2011-2012	Kawasaki Versys
PRODUCT	
040BG143510	Kawasaki Versys Chassis Protector Kit

 Read through all instructions before beginning installation. Motorcycle can be extremely hot. Let motorcycle cool down before beginning installation. Always wear hand and eye protection and take precautionary measures to avoid injury.

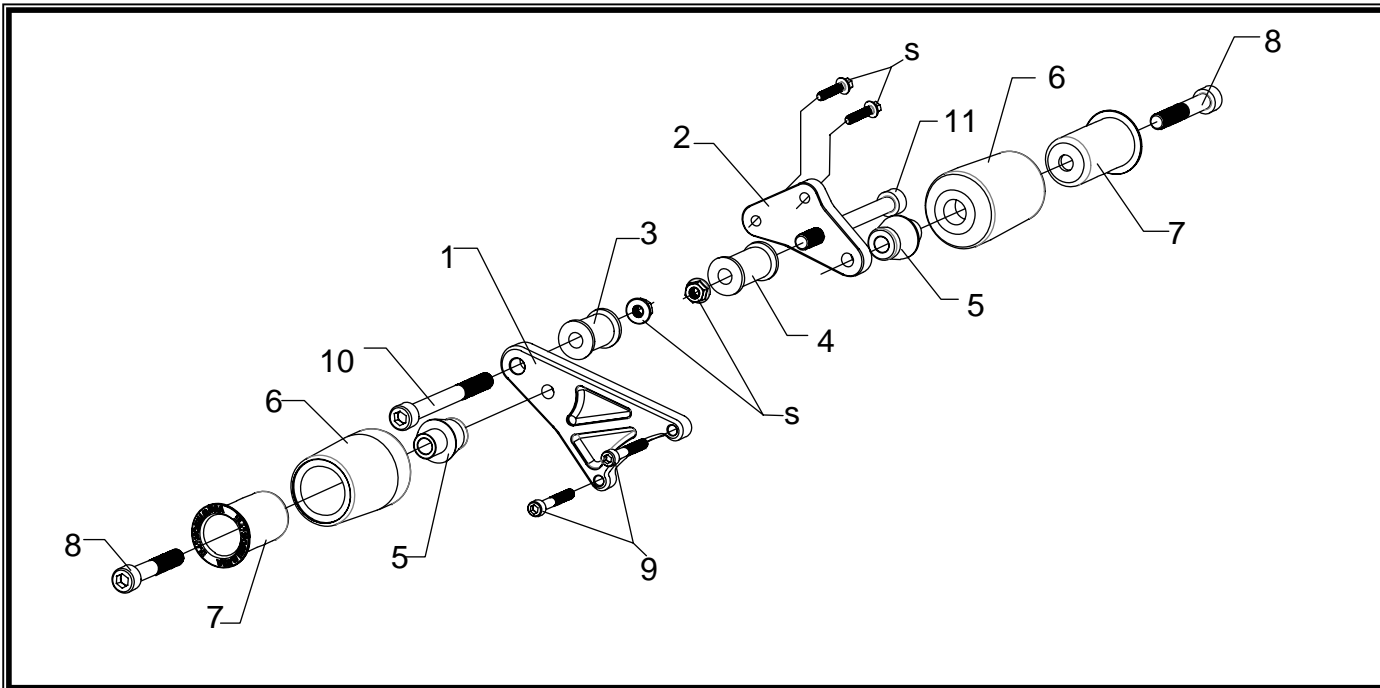

No.	Part #	Description	Qty
1	14351-CPBKT-L	Left Chassis Protector Bracket	1
2	14351-CPBKT-R	Right Chassis Protector Bracket	1
3	14351-CP-SPCL	Left Aluminum Spacer	1
4	14351-CP-SPCR	Right Aluminum Spacer	1
5	1115-A02-03	Aluminum Chassis Protector Spacer	2
6	040BG-ML	Chassis Protector	2
7	040BG-MLI-10	Aluminum Insert	2
8	M10X1.25X60	10mm x 1.25 x 60mm Socket Head Cap Screw	2
9	M6X40	6mm x 40mm Socket Head Cap Screw	2
10	M10X100	10mm x 100mm Socket Head Cap Screw	1
11	M10X1.25X110	10mm x 1.25 x 110mm Socket Head Cap Screw	1
**	17020C	Sticker Sheet	2

-TOOLS REQUIRED-

Metric Socket Set

Combination Wrench Set

Torque Wrench

Metric Allen Wrench Set

-INSTALLATION-

1. **Remove left side engine mount bolt.**

IMPORTANT: INSTALL CHASSIS PROTECTOR ONE SIDE AT A TIME. REMOVING BOTH LEFT AND RIGHT ENGINE MOUNT BOLTS SIMULTANEOUSLY MAY CAUSE ENGINE TO SAG OR DROP RESULTING IN MOUNTING HOLES TO BE MISALIGNED.

2. **Remove the (2) left side engine case bolts shown in Fig. 1.**
3. **Using the hardware provided in the kit, install left side chassis protector as shown on the parts diagram using the stock nut. Torque bolts to factory specifications.**
Note: Left Aluminum Spacer is shorter.



Fig. 1 Left Side

4. **Remove right side engine mount bolt.**
5. **Remove the (2) bolts securing engine bracket onto frame.**
Note: The stock engine bracket and engine spacer collar will not be reused.
6. **Install provided right side chassis protector bracket using the (2) 8mm x 22mm stock bolts.**
7. **Using the hardware provided in the kit, install right side chassis protector as shown on the parts diagram. Torque bolts to factory specification.**
Note: Right Aluminum Spacer is longer.



Fig. 2 Right Side